

OPERATING INSTRUCTIONS & SERVICE MANUAL

SOLID-STATE AM/FM STEREO TUNER

SANSUI TU-888

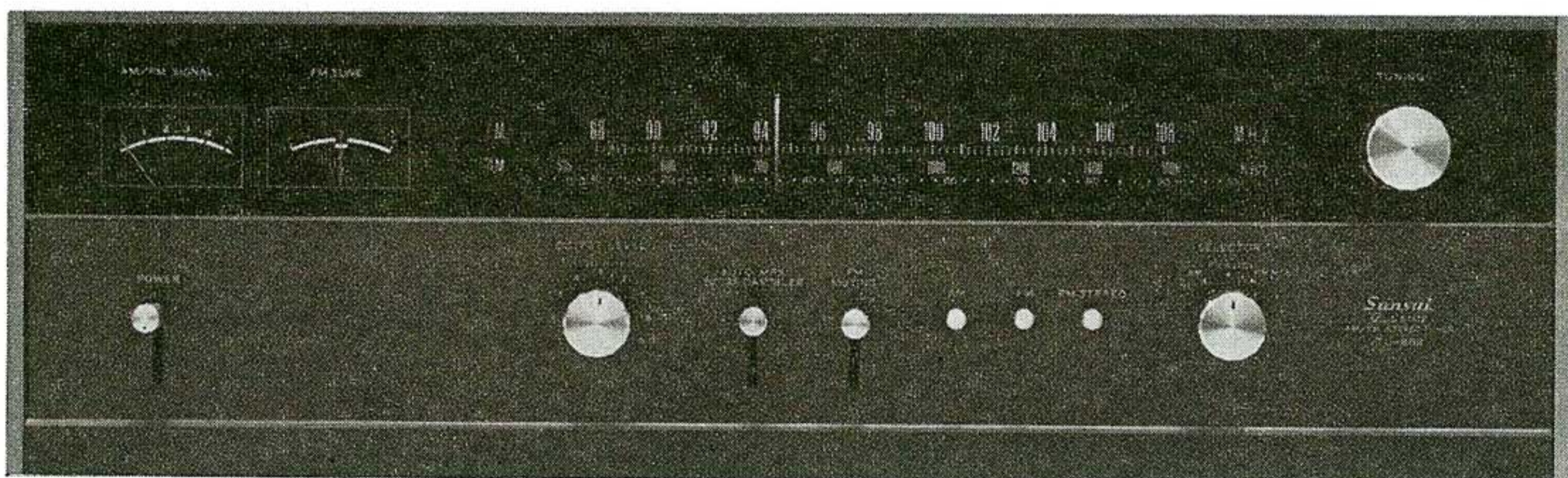

SANSUI ELECTRIC COMPANY LIMITED

Congratulations on joining the thousands of proud, satisfied owners of quality stereo components from Sansui.

The TU-888 is the most advanced professional solid state AM/FM stereo tuner ever manufactured by Sansui. As such, it incorporates the cream of our technology and long experience with audio equipment. Particularly, the FM tuner section is designed with the idea that FM broadcast is becoming an important program source which rates the same consideration as tapes and disks.

The FM front end with FET and the IF amplifier stage with IC and a ceramic filter together allow the tuner to offer unparalleled high sensitivity and stability, superior separation and low distortion characteristics.

The TU-888 also incorporates a number of special provisions designed to insure quality reception of FM stereo broadcasts. Such as auto MPX noise canceler and an LC type leak filter with a sharp cutoff characteristic. And, of course, it comes complete with a full assortment of accessory circuits. Among them: an FM antenna switch, muting level adjustor, output level adjustor, two output terminals, and an AM/FM/ FM Stereo indicator.

The TU-888 features the refined dull black panels common to all TU series professional tuners from Sansui. Together with the wide dial with twin tuning meters, linear dial scale for the FM band and a selflighting dial pointer, they make the tuner as smooth to the eye as it is to the ear.

The TU-888 comes with the full confidence and guarantee of the manufacturer. It is now up to you to read the contents of this manual carefully in order to operate it correctly and obtain the maximum performance it is capable of offering for many years to come.

CONTENTS

OPERATIONS SECTION

SWITCHES AND CONTROLS.....	3, 4
CONNECTIONS	5, 6
OPERATIONS	7
MAINTENANCE	7, 8, 9
SPECIFICATIONS	9
CHARACTERISTICS	10

SERVICE SECTION

TROUBLESHOOTING CHART	11, 12
DISASSEMBLY PROCEDURE/DIAL MECHANISM	13
BLOCK DIAGRAM	14
ALIGNMENT	15, 16, 17
PRINTED CIRCUIT BOARDS AND PARTS LIST ...	18, 19, 20, 21, 22, 23, 24
ACCESSORIES	25
OTHER PARTS AND THEIR POSITION ON CHASSIS	25, 26

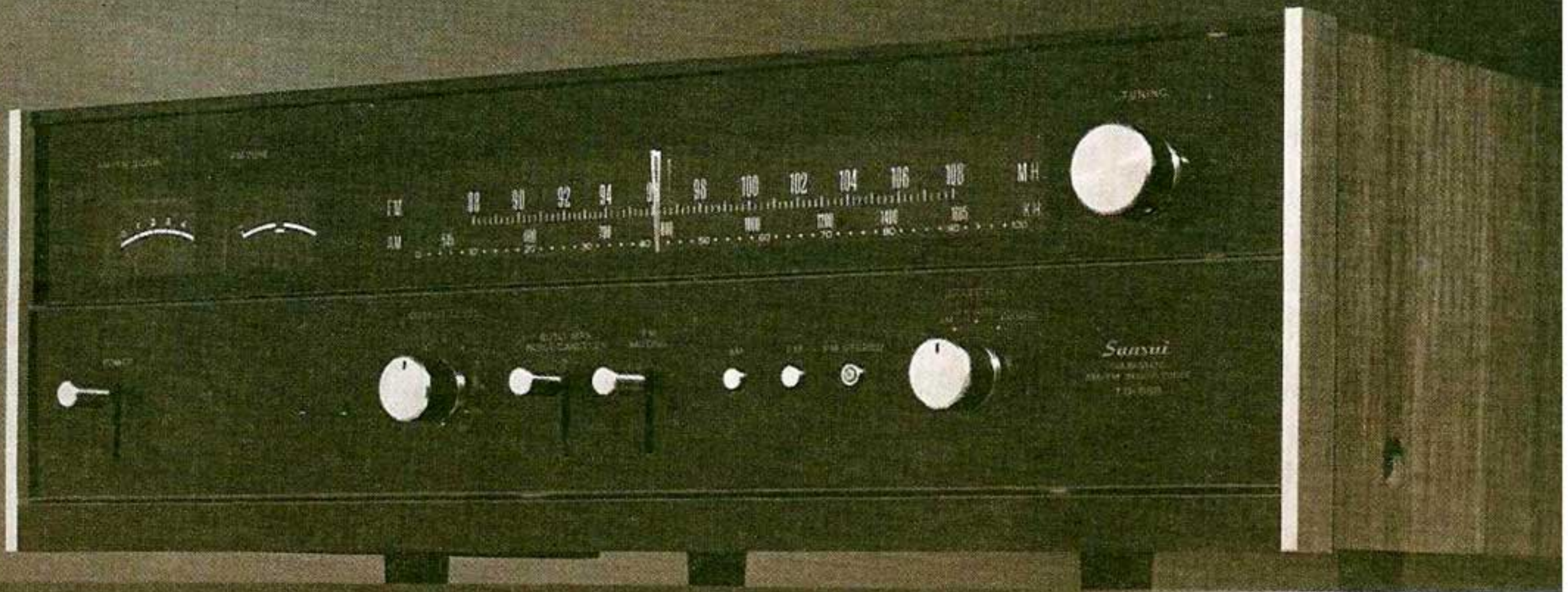

TUNING

FM 88 90 92 94 96 98 100 102 104 106 108 MHz
AM 540 560 580 600 620 640 660 680 700 720 740 760 780 800 820 840 860 880 900 920 940 960 980 1000 1020 1040 1060 1080 1100 1120 1140 1160 1180 1200 1220 1240 1260 1280 1300 KHz

1 2 3 4

POWER

VOLUME

6.75 SPK
RMS CAPACITY

FM
AUTO

AM

FM

FM

FM

TUNING

Sansui
CAR STEREO
MODEL TRS-5000
1970-1975

SWITCHES AND CONTROLS

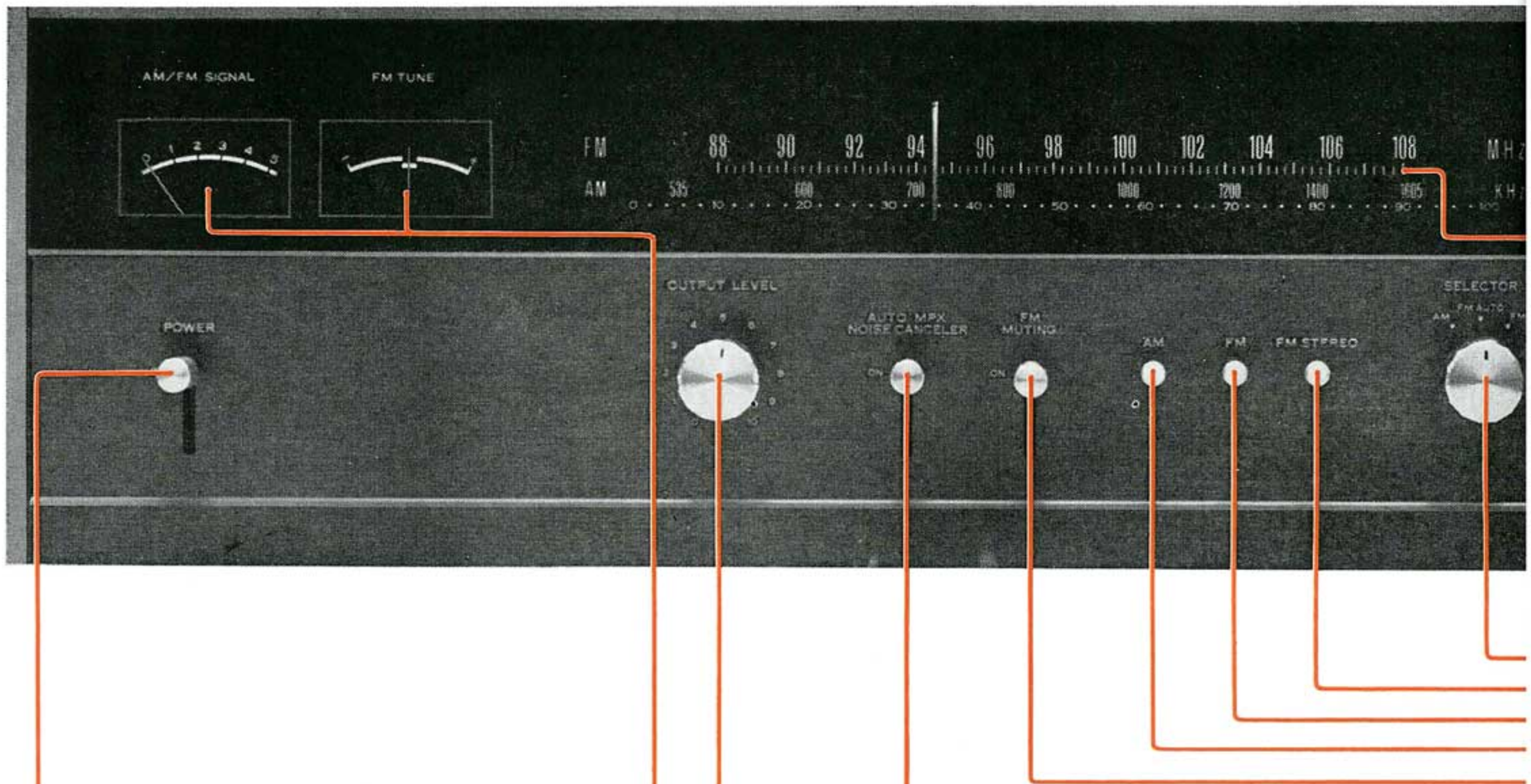

Power Switch

Set the lever in its up position to turn on the tuner. Set it in its down position to turn the tuner off.

FM Tune & AM/FM Signal Meters

These meters aid in pinpointing a station. The FM station is correctly tuned when the Signal meter needle swings as far to the right as it will go for maximum signal strength while the Tune meter is centered. For the AM stations, only the Signal meter can be used as described above.

FM Auto MPX Noise Canceler

Turn on this switch if you hear too much noise on an FM stereo broadcast; the noise will be substantially suppressed and the broadcast will be much more pleasant to listen to, although the stereo separation may be somewhat impaired. The MPX Noise Canceler circuit is specially designed so that it will go off of itself, should the noise quiet down. Should this happen, the stereo separation will be automatically restored to normal.

If you value stereo separation more than a broadcast with less noise, keep the switch off.

Output Level Control

Adjust the output level of the tuner with this control to suit your amplifier. Turn it clockwise to increase the output level and counterclockwise to reduce it.

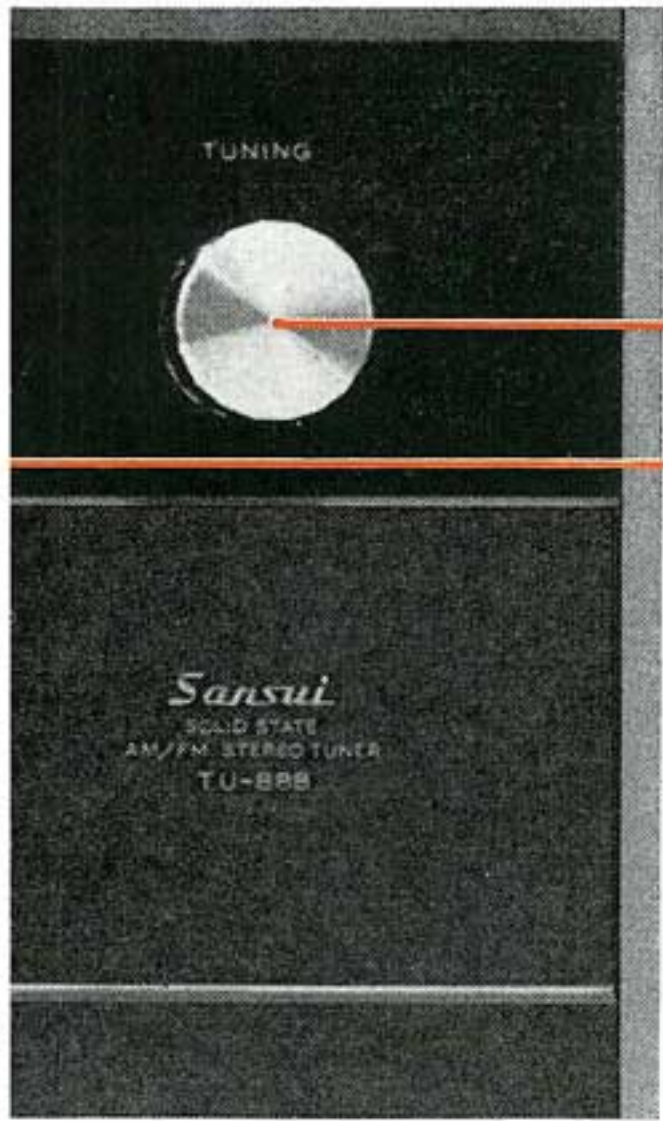

Tuning Knob

Turn this knob to find the desired station. The two meters at the left of the dial scales aid in pinpointing the station.

Dial Scales

The upper large numbered dial is the FM station tuning dial. The lower small numbered dial is the AM station tuning dial. To select the desired station, turn the Tuning knob.

Selector Switch

AM: Use this position for AM programs.
FM AUTO: With the switch in this position, the tuner selects between monophonic and stereo FM programs automatically depending on which program is being received.
FM MONO: Use this position for monophonic FM programs.

FM Indicator

This indicator is lit when the Selector switch is turned to any FM position.

AM Indicator

This indicator is lit when the Selector switch is turned to the AM position.

FM Muting Switch

This switch suppresses interstation tuning noise when selecting FM stations. It should be used sparingly, particularly if the tuner is located in a weak signal area. When you want to pick up a weak station, this lever should be kept in its down position.

FM Stereo Indicator

This indicator lights up to give notice when a stereo program is being received. It is not illuminated for a monophonic FM program.

CONNECTIONS

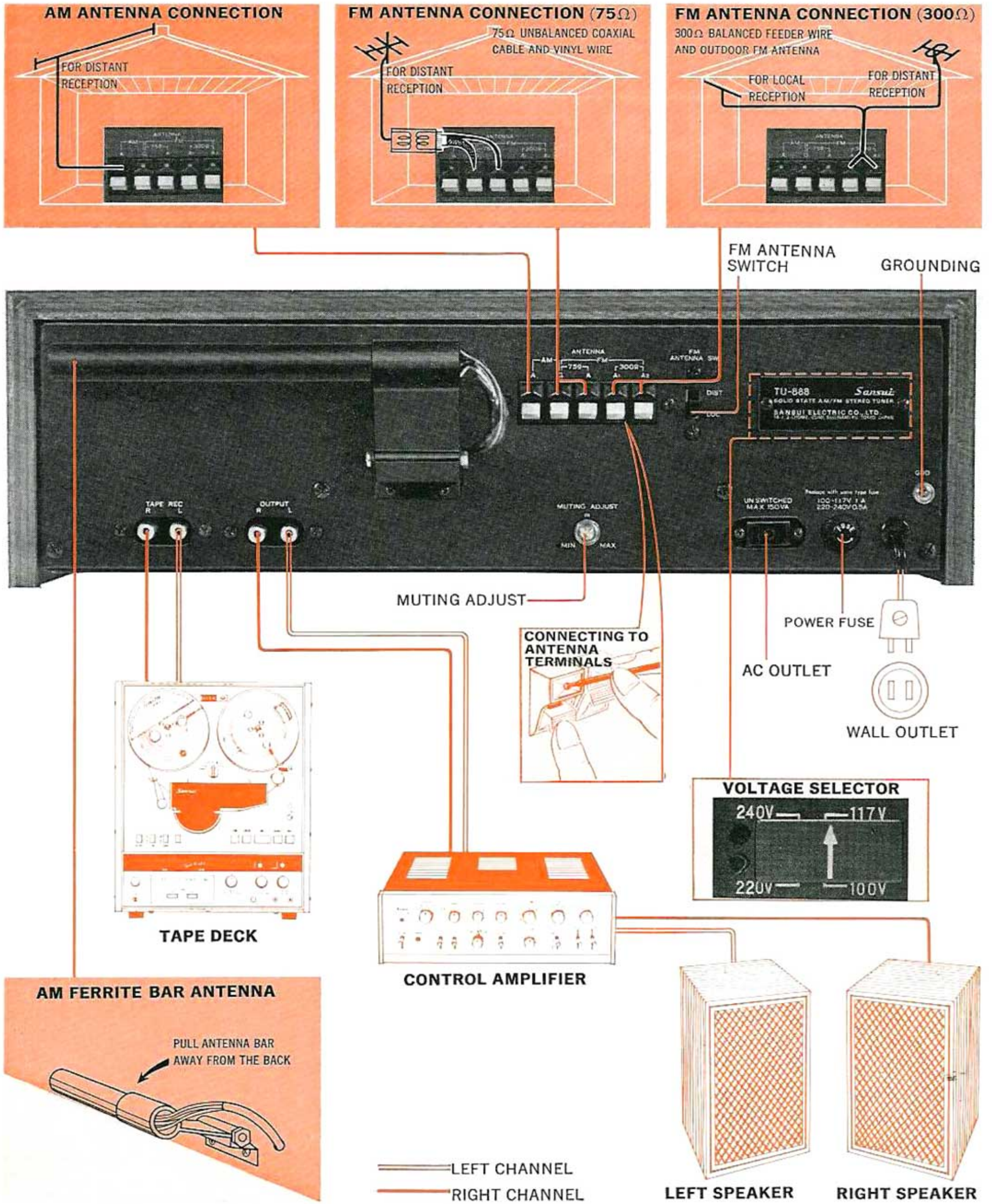

ANTENNA CONNECTIONS

The quality of reception that can be expected from the TU-888 is largely dependent on the correct positioning and use of antennas. The following procedures are recommended for noise-free reception.

Built-in AM Ferrite Antenna

This sensitive antenna, located on the rear panel of the tuner, is usually adequate for strong AM reception. To use, pull it down and away from the back of the tuner until it comes to a stop halfway between the top and the bottom of the tuner.

Outdoor AM Antenna

In ferroconcrete buildings or in areas remote from the broadcasting station, the built-in ferrite bar antenna may be inadequate for strong AM reception. An outdoor antenna then becomes necessary. This can be accomplished by connecting the PVC wire accompanying the tuner to the antenna terminal marked AM-A on the back panel. Run this wire to an antenna that has been installed outdoors and away from the building. At the same time, the unit should be grounded. Position the outdoor antenna where reception is strongest while actually receiving a broadcast. And, for reasons of safety, be sure to attach a lightning arrester to the outdoor antenna.

FM Antenna

Where FM broadcasting stations are near and FM signals are strong, satisfactory FM reception can be obtained by using the dipole accompanying the tuner. Connect the two leads from the dipole to the antenna terminals marked FM-300Ω A₁ and A₂ on the rear panel, then fully extend the wire to a T shape and fix it to a wall or ceiling where it allows the strongest reception.

If the TU-888 is used in a thick-walled building or in an area remote from FM broadcasting stations, the indoor dipole wire antenna may be inadequate for strong signal reception. An outdoor antenna designed exclusively for FM reception should then be installed.

FM antennas of the 300 ohm balanced type and 75 ohm unbalanced type can be used with the TU-888. Connect either antenna to the matching antenna terminals on the rear of the tuner. The 300 ohm

dipole should be connected to the FM antenna terminals A₁ and A₂ as shown on page 5.

If a 75 ohm coaxial cable is used, connect the conductor to the antenna terminal FM-75Ω A, and the shielding wire to the terminal G.

NOTE: FM sensitivity cannot be raised simply by lengthening the antenna. Adjust the antenna's height and direction while actually listening to a broadcast for the best reception.

AMPLIFIER CONNECTIONS

To connect a control amplifier to the TU-888, use the two cables supplied with the tuner. Connect the R output on the rear panel of the tuner to the right channel input marked TUNER or AUX on the rear of the amplifier. The left channel connection are made between the L output of the tuner and the left TUNER or AUX input of the amplifier.

TAPE DECK CONNECTIONS

A pair of jacks marked TAPE REC allow connection of a tape deck (or tape recorder) for recordings directly from the TU-888. The connection must be made with shielded wire. If you want to monitor during the recording process, connect the playback outputs of the 3-head tape deck to a control amplifier connected to the speakers.

OPERATIONS

To receive AM broadcasts:

1. Turn the SELECTOR switch to AM.
2. Select the desired AM station on the AM dial with the TUNING knob. It is properly tuned when the needle in the SIGNAL meter moves as far to the right as possible.
3. Turn the OUTPUT LEVEL control as required.

To receive FM broadcasts:

1. Turn the SELECTOR switch to FM MONO for monophonic programs, to FM AUTO for both monophonic and stereo broadcasts.

NOTE: If too much disturbing noise accompanies a stereo broadcast in the FM AUTO positions, first switch the AUTO MPX NOISE CANCELER on, and if the noise is still too disturbing, turn the SELECTOR to FM MONO to hear the same broadcast monaurally.

2. Select the desired FM station on the FM dial with the TUNING knob. It is properly tuned when the needle in the SIGNAL meter moves as far to the right as possible while the TUNE meter is centered. The FM STEREO indicator glows automatically whenever an FM stereo broadcast is being received.
3. When too much interstation noise occurs during tuning, turn the FM MUTING switch to its ON position.
4. Turn the OUTPUT LEVEL control required.

Muting Adjust Control

If a weak FM station that you want to receive cannot be heard when selecting it with the front FM MUTING switch set in its ON position, turn this control clockwise with a screwdriver. To listen to strong FM stations only, turn it counterclockwise.



Local-Distant Antenna Switch

This switch is used to attenuate very strong signals to avoid overloading. In strong signal areas, this switch should be set to LOC. In other locations, this switch should be set to DIST.



Grounding

Connect one end of vinyl or enameled wire to the terminal screw marked GND or AM-G on the rear of the tuner, attach a copper plate to the other end, and bury it underground. Whenever an outdoor AM antenna is used, grounding becomes necessary. In all cases, grounding is desirable since it allows a better SN ratio to be obtained.

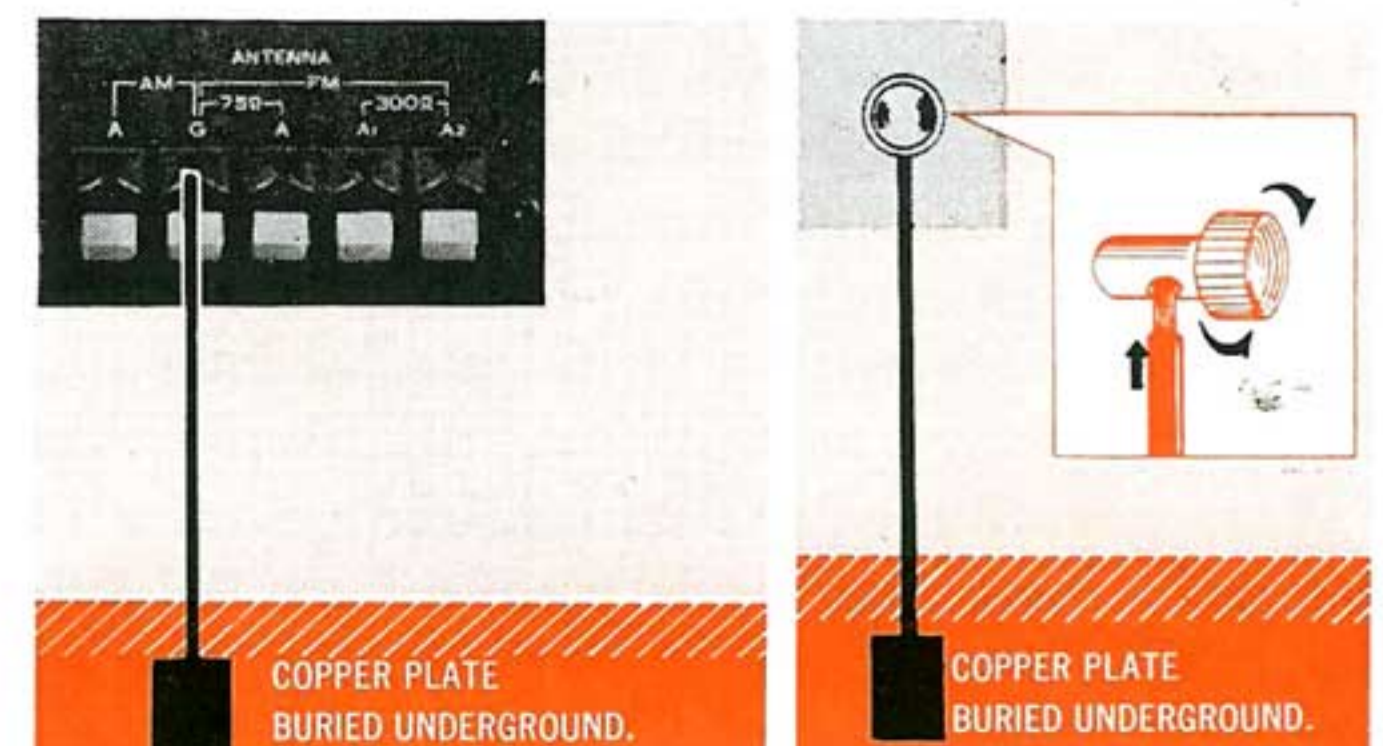

AC Outlet

The AC outlet on the rear panel is used to serve as power supply source for a tape deck or other components. This outlet has a maximum rating of 150 VA.



Power Fuse

CAUTION: For the power supply voltage of 100 to 117 volts, use a 1 A fuse; for 220 to 240 volts, use a 0.5 A fuse.

If the tuner fails to operate when the power is switched on, its power fuse may be blown. To check, turn the fuse holder at the rear of the tuner to the left. If it is blown, disconnect the tuner from its power source and replace the fuse with an *identical 1 (or 0.5) A fuse*, after finding and eliminating the source of trouble that caused the fuse to blow. Using wire or a fuse of a different capacity as a stop-gap measure is dangerous and should be avoided. If the new fuse blows when the power is switched on again, contact your nearest Sansui dealer.



Where to Place

Since transistors are extremely susceptible to heat, the TU-888 has been designed to diffuse heat through the top and rear of its case. Therefore, special consideration should be given to where it will be used before installing the system. It should not be operated in a place where it is exposed directly to the sun, near radiators or other heat-generating sources, and it should never be mounted in an air-tight cabinet. Finally nothing should be placed on top of it.

Wire Connections

When connecting tape decks, amplifier or other components to the TU-888, be sure to use shielded wire. The use of an ordinary cord or vinyl wire may cause humming and buzzing. The length of the shielded wire used should be shorter than 5 feet. Be sure that all lead wires between the amplifier and components are properly connected. If the connections are loose or in touch with other parts, the amplifier will not function properly, may pickup noise, and even breakdown over a period of time. Also be sure to read the manufacturer's instructions for any component before connecting it to the TU-888.

MAINTENANCE/SPECIFICATIONS

Voltage Adjustment

To reach the voltage selector, remove the two screws from the nameplate on the rear panel and then remove the nameplate. The voltage selector makes it possible to operate the TU-888 at the correct volt in any area. The volt has been pre-adjusted at the factory, but can be easily readjusted as follows:

1. Set the arrow on the voltage selector plug to the required volt: 100, 117, 220 or 240 volts.
2. The power fuse should also may be changed when the a.c. line voltage is changed. For 100–117 volt operation, a 1 ampere fuse is required. For 220–240 volt operation, the fuse should be changed to a 0.5 ampere fuse.

Note: The Voltage selector can be also used to eliminate the trouble caused by the considerable voltage fluctuation. In this case, it should be set to the peak voltage.

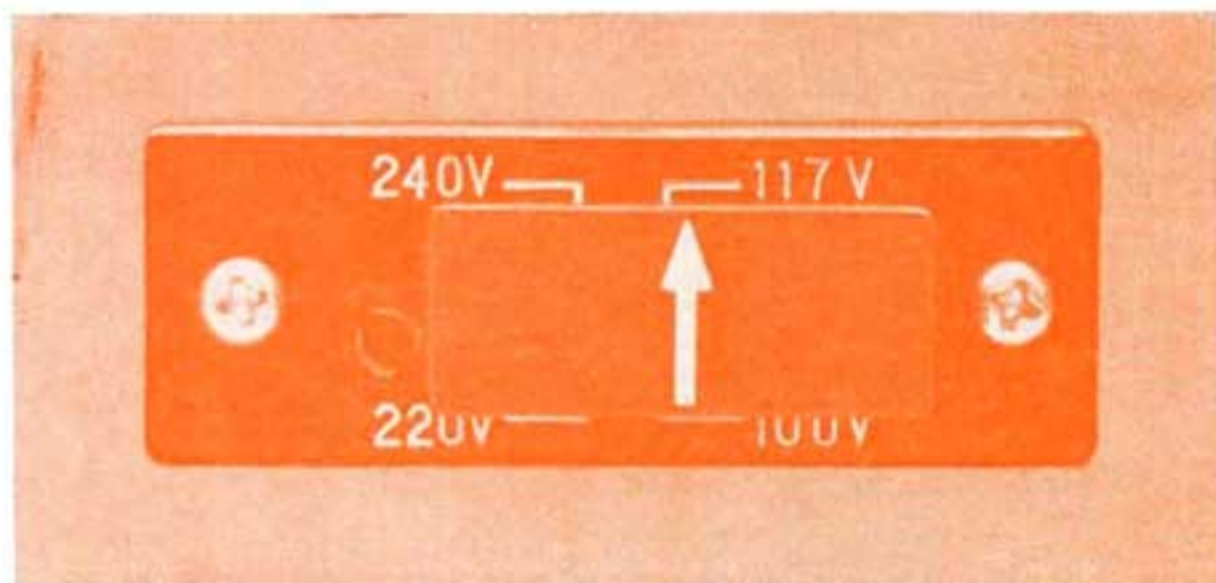

FM SECTION

TUNING RANGE:	88 to 108MHz
SENSITIVITY (20dB quieting):	1.4 μ V
(IHF):	1.8 μ V
TOTAL HARMONIC DISTORTION:	less than 0.3% (mono), 0.5% (stereo)
SIGNAL TO NOISE RATIO:	better than 70dB
SELECTIVITY:	better than 70dB
CAPTURE RATIO (IHF):	2.0dB
IMAGE FREQUENCY REJECTION:	better than 73dB
IF REJECTION:	better than 80dB
SPURIOUS RESPONSE REJECTION:	better than 90dB
STEREO SEPARATION:	better than 38dB at 400Hz
SPURIOUS RADIATION:	less than 34dB
CARRIER LEAK SUPPRESSION:	better than 70dB
ANTENNA INPUT IMPEDANCE:	300 ohms balanced, 75 ohms unbalanced
FREQUENCY RESPONSE:	50 to 15,000Hz +1dB, -2dB

AM SECTION

TUNING RANGE:	535 to 1,605kHz		
SENSITIVITY (bar antenna):	150 μ V at 1,000kHz		
(IHF):	20 μ V at 1,000kHz		
SELECTIVITY:	better than 25dB at 1,000kHz		
IMAGE FREQUENCY REJECTION:	better than 65dB at 1,000kHz		
IF REJECTION:	better than 70dB		
OUTPUT			
OUTPUT LEVEL:	0 to 1.5V		
TAPE REC:	0.4V		
LOAD IMPEDANCE:	more than 30k ohms		
CONTROLS			
OUTPUT LEVEL			
FM MUTING LEVEL			
SWITCHES			
FM MUTING:	ON, OFF		
AUTO MPX NOISE CANCELER:	ON, OFF		
FM ANTENNA:	DISTANT, LOCAL		
SELECTOR:	AM, FM AUTO, FM MONO		
SEMICONDUCTORS			
Transistors; 37	Diodes; 21	FET; 2	I.C. 1
Zener Diodes; 2	Thyristor; 1		
POWER REQUIREMENTS			
POWER VOLTAGE:	100, 117, 220, 240V		
	50/60Hz		
POWER CONSUMPTIONS:	19W		
DIMENSION:	460mm(18 $\frac{1}{10}$ ")W, 140mm (5 $\frac{1}{2}$ ")H, 305mm(12")D		
WEIGHT:	7.3kg(16 lbs)		

CHARACTERISTICS

FM MPX SEPARATION

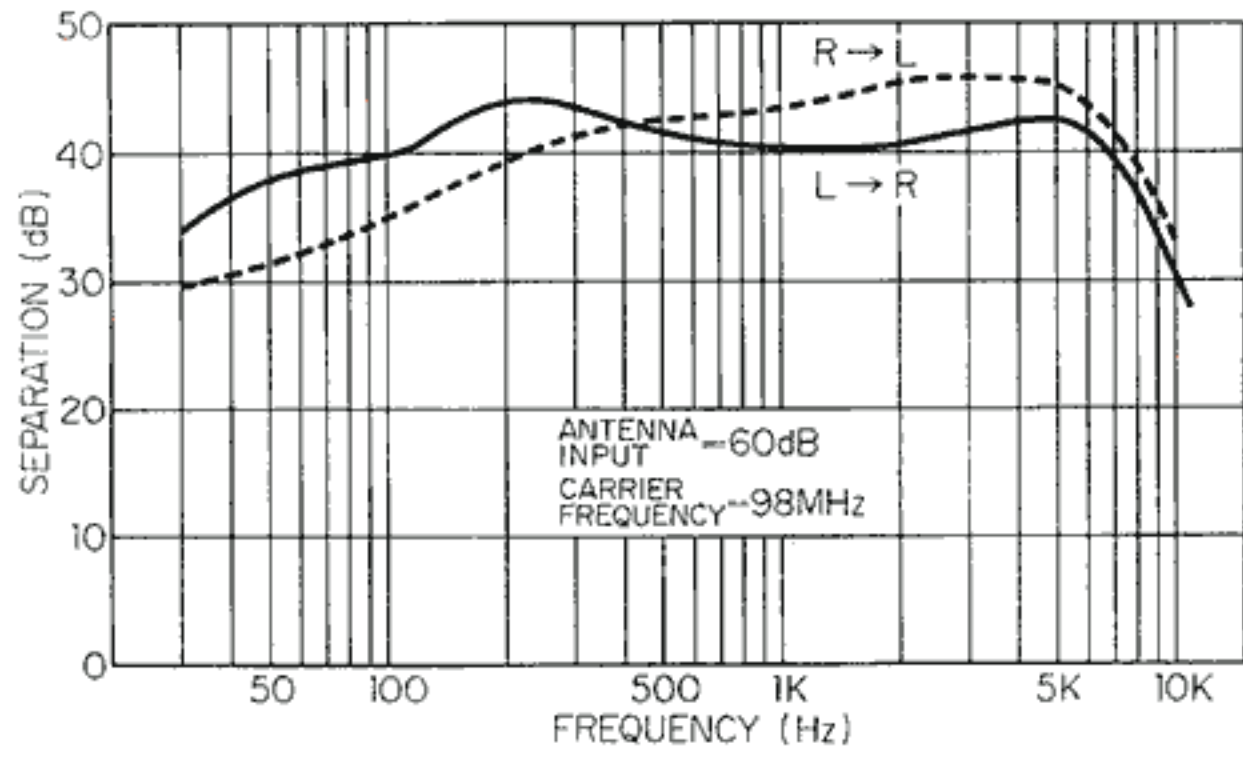

CAPTURE RATIO (IHF)

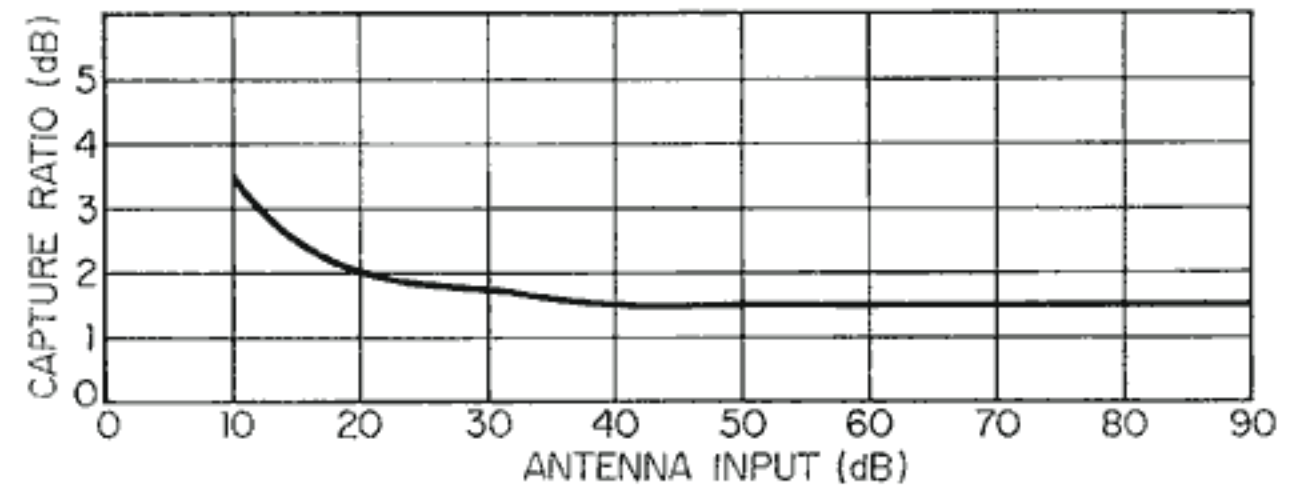

FM SELECTIVITY

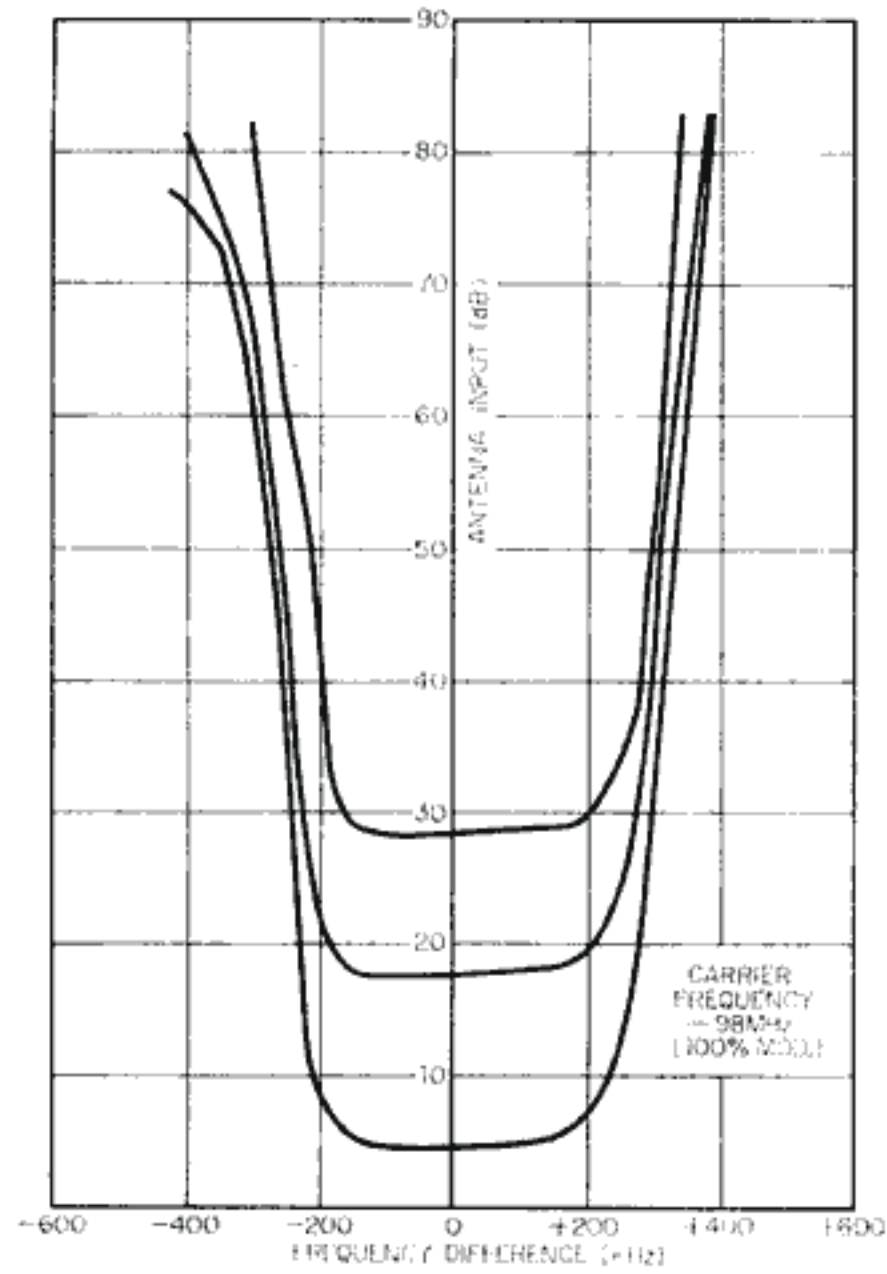

FM SENSITIVITY & IMAGE RATIO

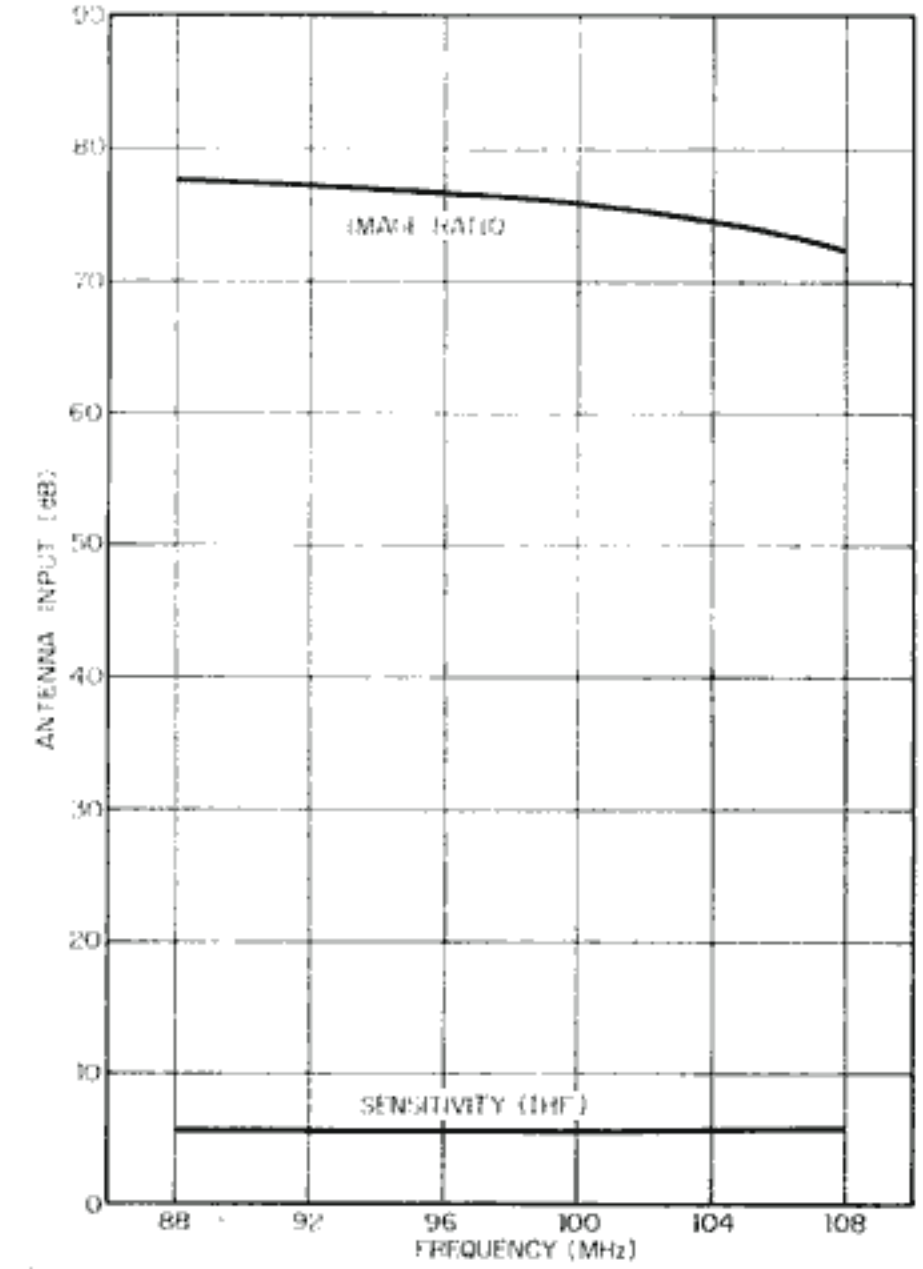

FM SIGNAL TO NOISE RATIO

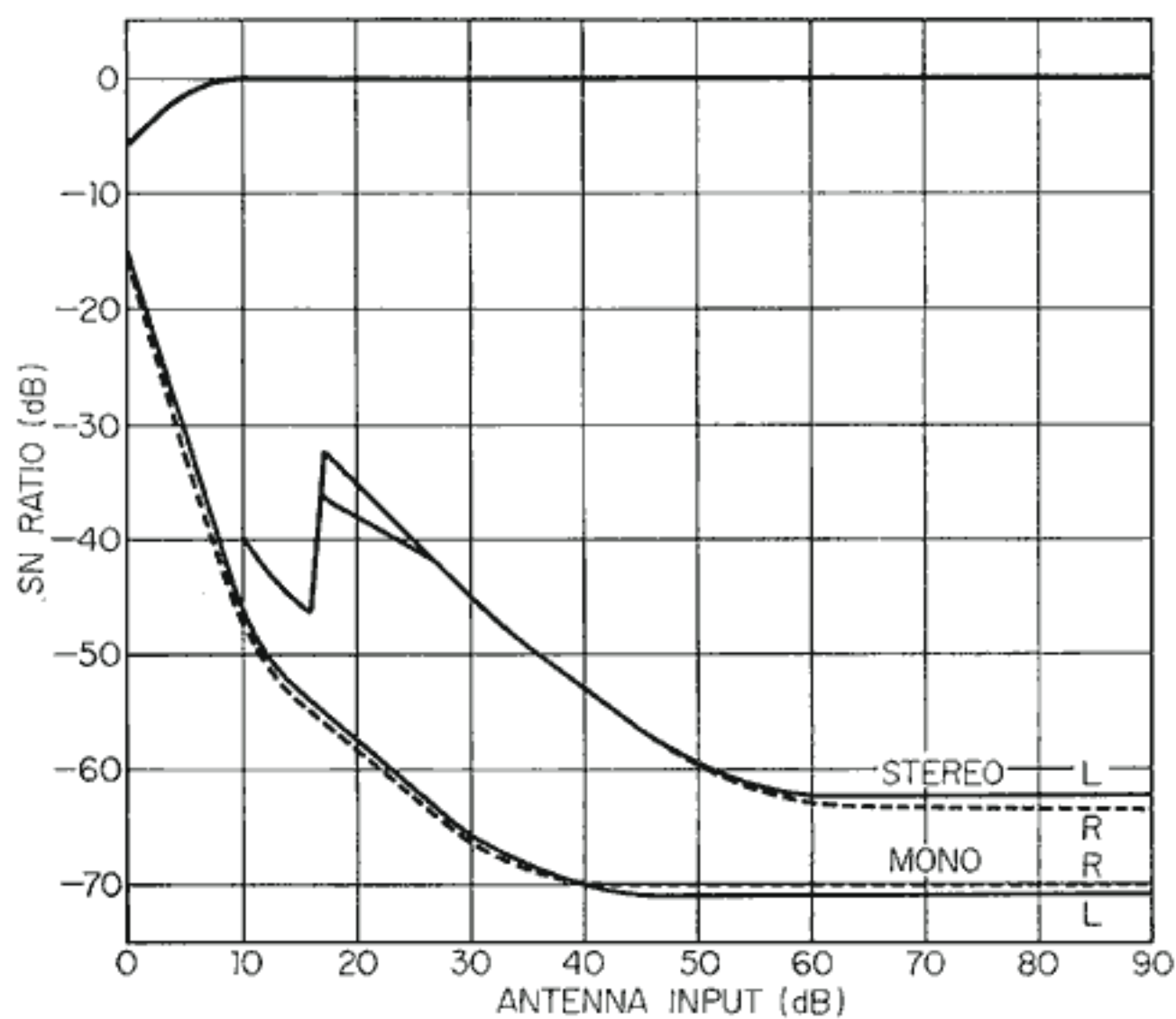

AM SENSITIVITY & IMAGE REJECTION

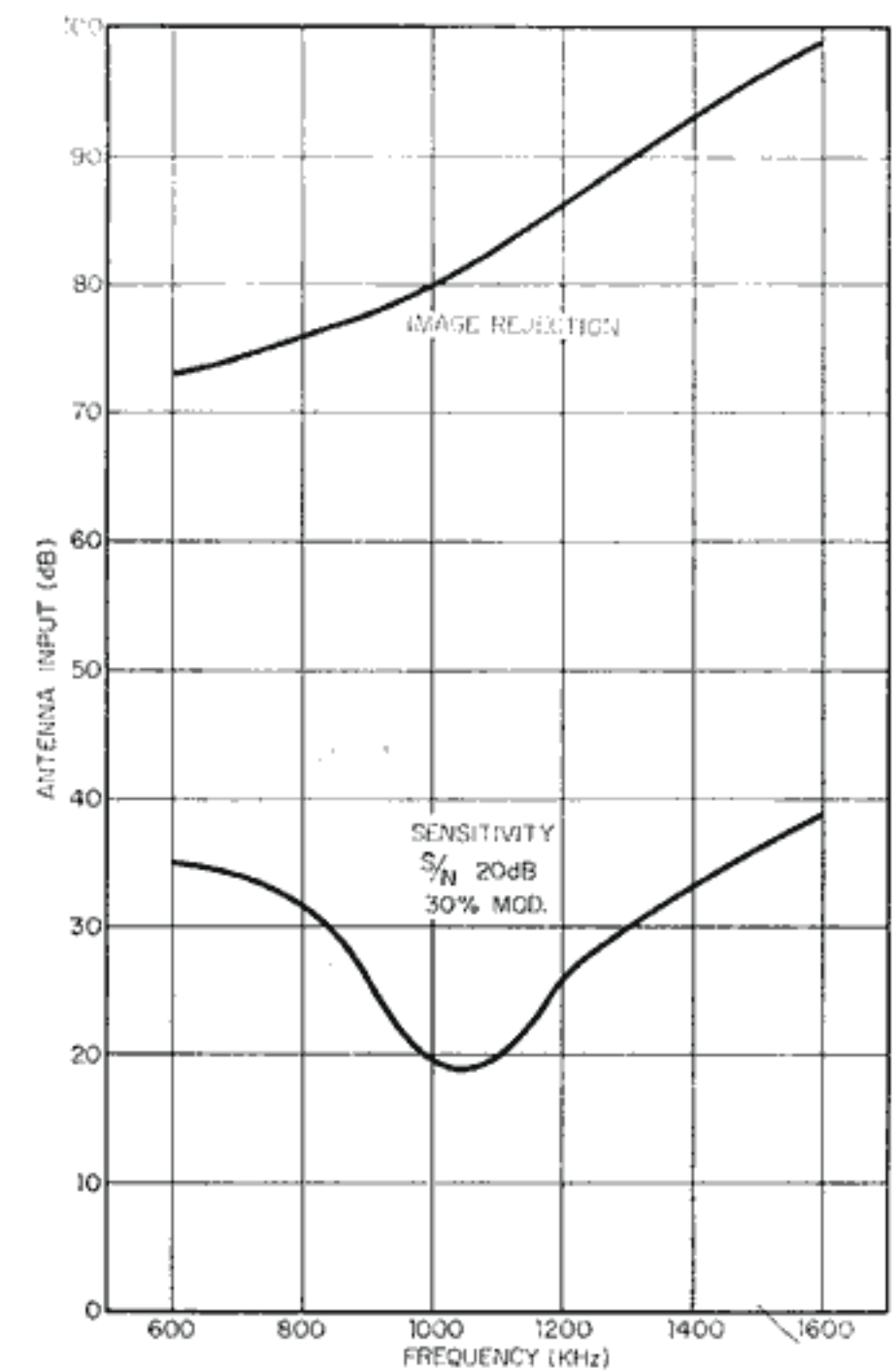

TROUBLESHOOTING CHART

This section has been prepared to help you quickly and correctly determine the causes, reasons and remedies in situations where your tuner does not perform satisfactorily. You will note that most of the causes result from improper handling or positioning of the receiver and not from internal defects. For situations that are not covered in this section however, and in instances where you are fairly sure that a breakdown in the tuner's circuitry has occurred, please consult your nearest Sansui dealer or Authorized Service Station.

PROGRAM	SYMPTOM	PROBABLE CAUSE	WHAT TO DO
AM, FM or FM stereo reception	A. Constant or intermittent noise heard at times or in a certain area.	<ul style="list-style-type: none"> * Discharge or oscillation caused by electrical appliances, such as fluorescent lamps, TV sets, D.C. motors, rectifier and oscillator. * Natural phenomena, such as atmospheric, statics, and thunderbolts. * Insufficient antenna input due to thick reinforced concrete walls of the building or long distances from the station. * Wave interference from other electrical appliances. 	<ul style="list-style-type: none"> * Attach a noise limiter to the electrical appliance that causes the noise, or attach it to the power source of the tuner. * Install an outdoor antenna and ground the tuner to raise the signal-to-noise ratio. * Reverse the power cord plug-receptacle connections. * If the noise occurs at a certain frequency, attach a wave trap to the ANT. input. * Keep the set at proper distance from other electrical appliances.
	B. The needle of the signal meter does not move well.	<ul style="list-style-type: none"> * The movement of the needle is one thing, the sensitivity of the tuner is another. 	<ul style="list-style-type: none"> * Tune the set for maximum signal strength.
	C. The zero point of the meter diverges much.	<ul style="list-style-type: none"> * Regional difference in field intensity. 	<ul style="list-style-type: none"> * The unit is not at fault.
AM reception	A. Noise heard at a particular time of a day, in a certain area or over a part of the dial.	<ul style="list-style-type: none"> * This results from the nature of AM broadcasts. 	<ul style="list-style-type: none"> * Install the antenna for maximum antenna efficiency. See "ANTENNA" in the operating instructions section. * In some cases, the noise can be eliminated by grounding the tuner or reversing the power cord plug-receptacle connections.
	B. High-frequency noise.	<ul style="list-style-type: none"> * Adjacent-channel interference or beat interference. * TV set too close to the audio system. 	<ul style="list-style-type: none"> * Although such noise cannot be eliminated, it is advisable to turn the amplifier's TREBLE control properly from midpoint to left and switch on the HIGH FILTER. * Keep the TV set at proper distance from the audio system.

PROGRAM	SYMPTOM	PROBABLE CAUSE	WHAT TO DO
FM reception	A. Noisy	* Poor noise limiter effect or too low S/N ratio due to insufficient antenna input.	* Adjust the dipole wire antenna (supplied) for maximum signal strength. * If this does not prove effective, use an outdoor antenna designed exclusively for FM. When you use a TV antenna for both TV and FM with the help of a splitter, make sure the TV reception is not affected. * An excessively long antenna may cause noise.
	NOTE: FM reception is affected considerably by the conditions of transmission by stations: power and antenna efficiency. As a result, you may receive one station quite well while having difficulty in receiving another station.		
	B. A series of pops is heard.	* Ignition noise caused by the starting of an automobile engine and/or other motors.	* Install the antenna and its lead-in wire at proper distance from the road or raise the antenna input as described above.
	C. Tuning noise between stations.	* This noise results from the nature of FM reception. As the station signal becomes weak, the noise limiter effect is also decreased. The amplification of the limiter, in turn, is enlarged and thus a big noise is generated.	* Turn on the FM MUTING switch. In as much as it also reduces the sensitivity, it should be used sparingly.
FM stereo reception	A. Noise heard during FM stereo reception while not heard during FM mono reception.	* The service area of the FM stereo broadcast is only half as much as that of the FM mono broadcast.	* Install the antenna for maximum antenna input. * Switch the AUTO MPX NOISE CANCELER to its ON position.
	B. Clearness of channel separation is decreased during the reception.	* Excess heat.	* Circulation of air is important to the tuner. Make sure that air can flow underneath.
	C. The stereo indicator blinks on and off.	* Interference	* The Indicator is not at fault. * Readjust VR ₄₀₂ .
	D. The stereo indicator blinks on and off even though a stereo station is not received.	* Interference	* The indicator is not at fault. * Readjust VR ₄₀₂ .

DISASSEMBLY PROCEDURE / DIAL MECHANISM

DISASSEMBLY PROCEDURE

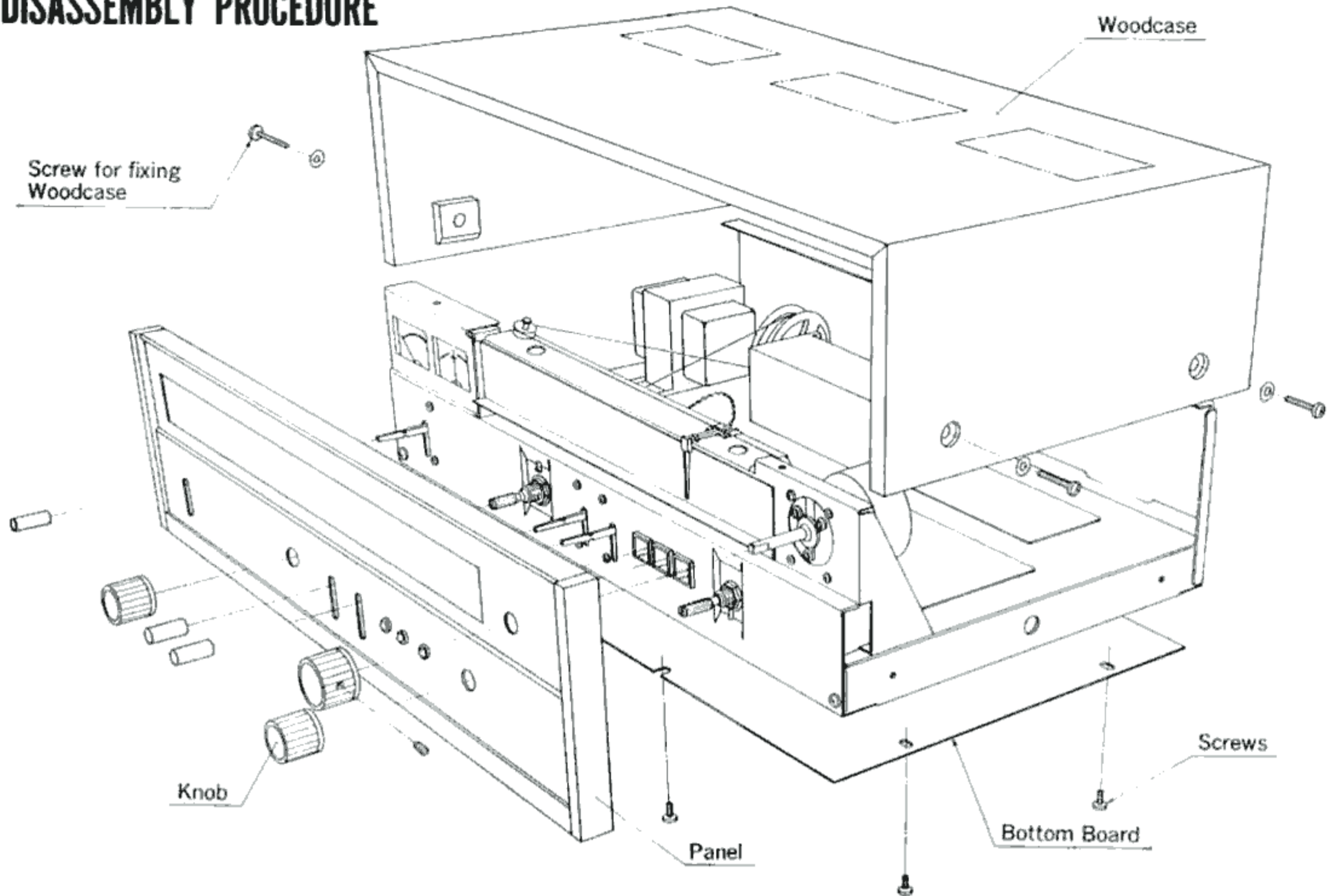

DIAL MECHANISM

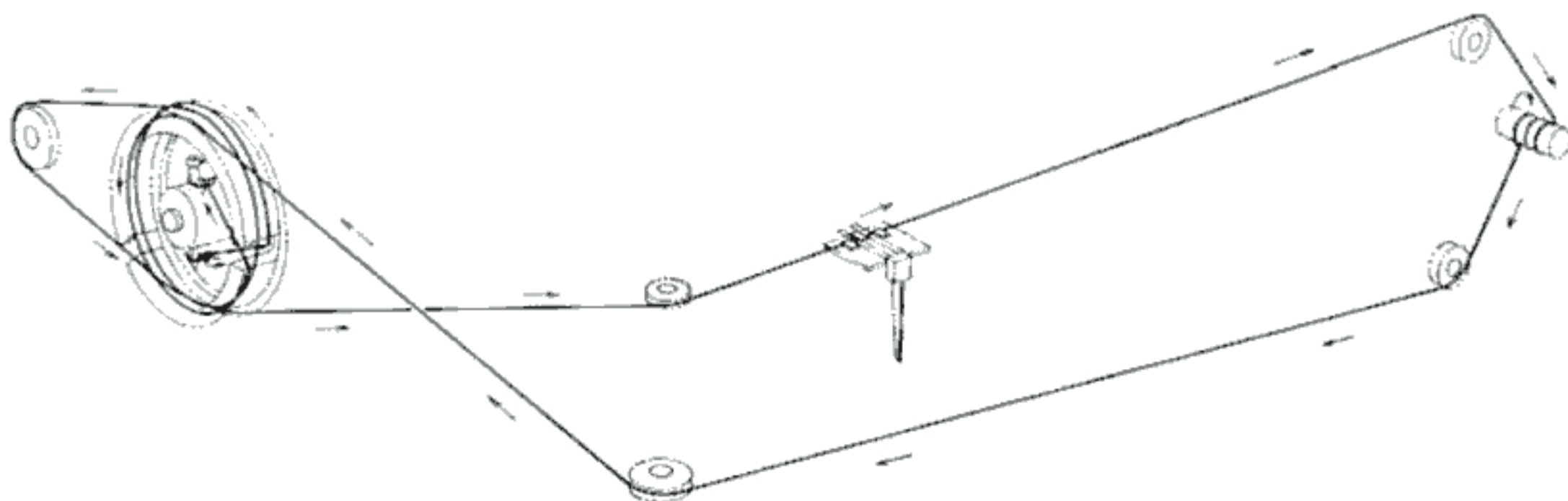

BLOCK DIAGRAM

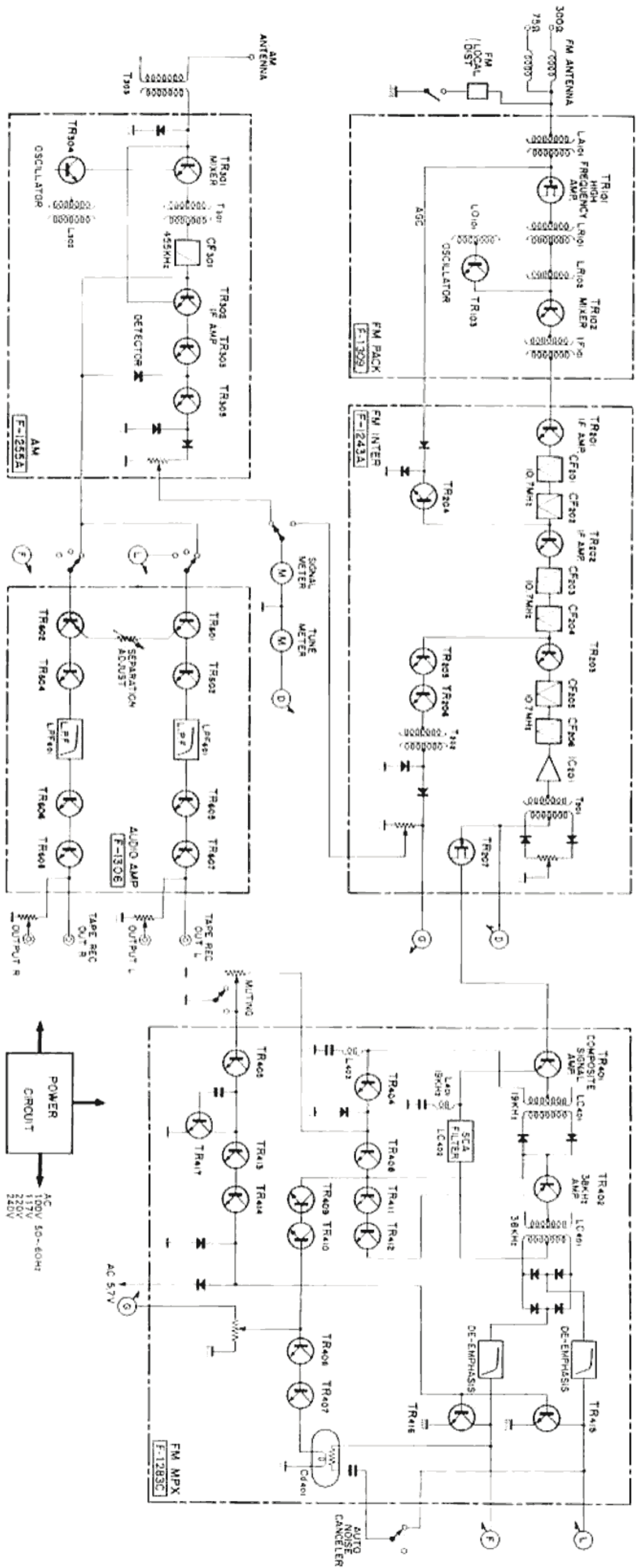

ALIGNMENT

TEST POINTS

- TC0101
- TC302
- TCR102
- TCR101
- TCA101
- TC301
- LA101
- LR101
- LR102
- IF101
- L0101
- 2B
- 2H
- 4A

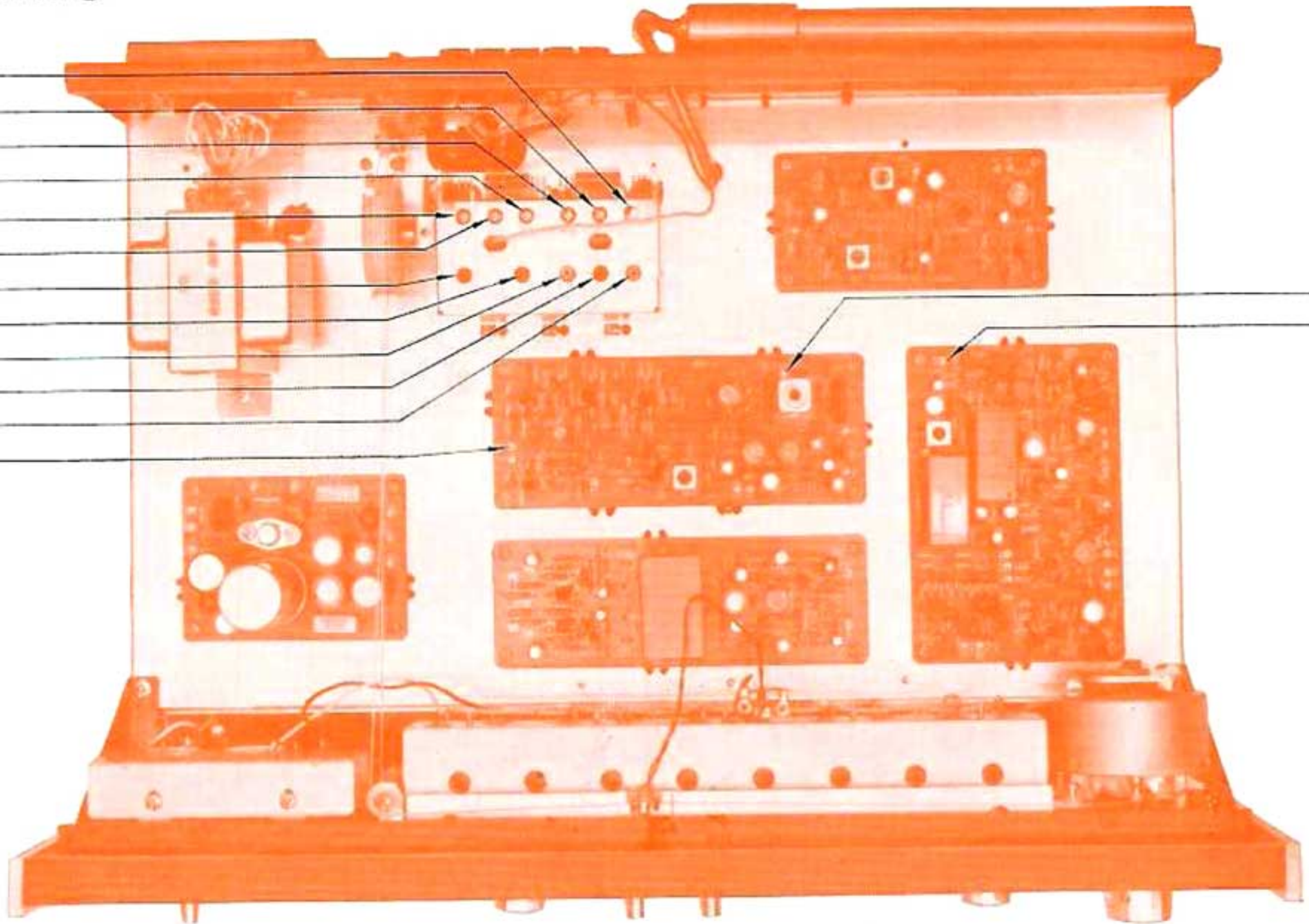

- 3D
- 2H
- 4A
- TP101
- 2B

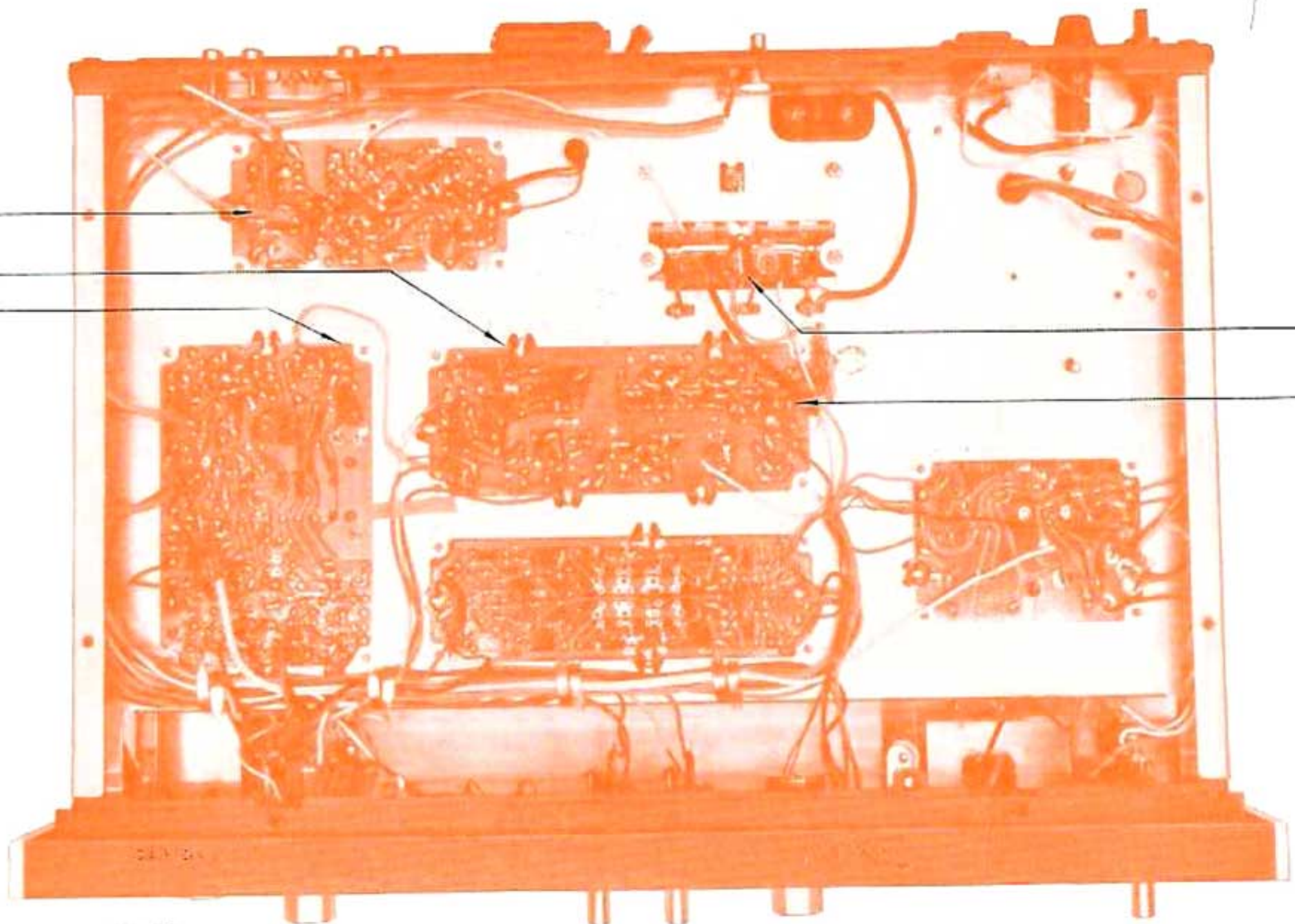

FM ALIGNMENT PROCEDURE

NOTE: To align, set the FM signal generator level to minimum.

Any internal parts replacement or changes you make in the TU-888 requires proper adjustment again. Appropriate test points and adjustments are given on pages 15~17.

Equipment required : 1. Sweep Generator 2. Oscilloscope 3. FM Signal Generator 4. Multiplex Stereo Generator 5. AC VTVM
6. Audio Oscillator 7. AM Signal Generator 8. Distortion Meter

STEP	ALIGN	GENERATOR	FEED SIGNAL	OUTPUT INDICATOR	DIAL SETTING	ADJUST	ADJUST FOR
1.	IF Transformer	10.7MHz ±200kHz Sweep generator	To TP ₁₀₁ via the 10pF ceramic capacitor	Oscilloscope is connected to 2B via the 10pF ceramic by using a detector probe		IF ₁₀₁	Best I.F.T. wave form
2.	Discriminator	10.7MHz ±200kHz Sweep generator	To TP ₁₀₁ via the 10pF ceramic capacitor	Oscilloscope is connected to 2H.		FM Discriminator transformer T ₂₀₁ primary and secondary	S curve
3.	O.S.C.	FM signal generator 88MHz 400Hz 100% Modulation	To antenna terminals	Oscilloscope and V.T.V.M. at output load	88MHz	O.S.C. coil L ₀₁₀₁	Maximum
4.	O.S.C.	FM signal generator 108MHz 400Hz 100% Modulation	To antenna terminals	Oscilloscope and V.T.V.M. at output load	108MHz	O.S.C. trimmer TC ₀₁₀₁	Maximum
5.	Repeat 3 and 4						
6.	RF Amp. Circuit	FM signal generator 90MHz 400Hz 100% Modulation	To antenna terminals	Oscilloscope and V.T.V.M. at output load	90MHz	Antenna coil L _{A101} , L _{R101} and L _{R102}	Maximum
7.	RF Amp. Circuit	FM signal generator 106MHz 400Hz 100% Modulation	To antenna terminals	Oscilloscope and V.T.V.M. at output load	106MHz	Trimmer TC _{A101} , TC _{R101} and TC _{R102}	Maximum
8.	Repeat 6 and 7.						

FM DISCRIMINATOR CHARACTERISTIC

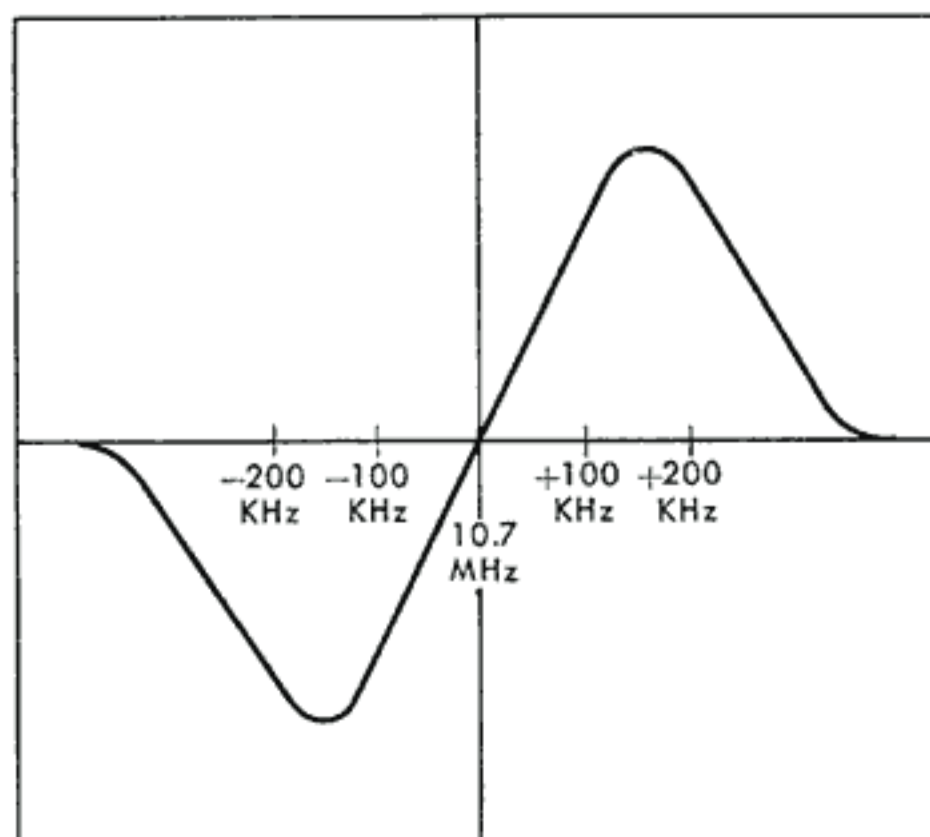

FM IF CHARACTERISTIC

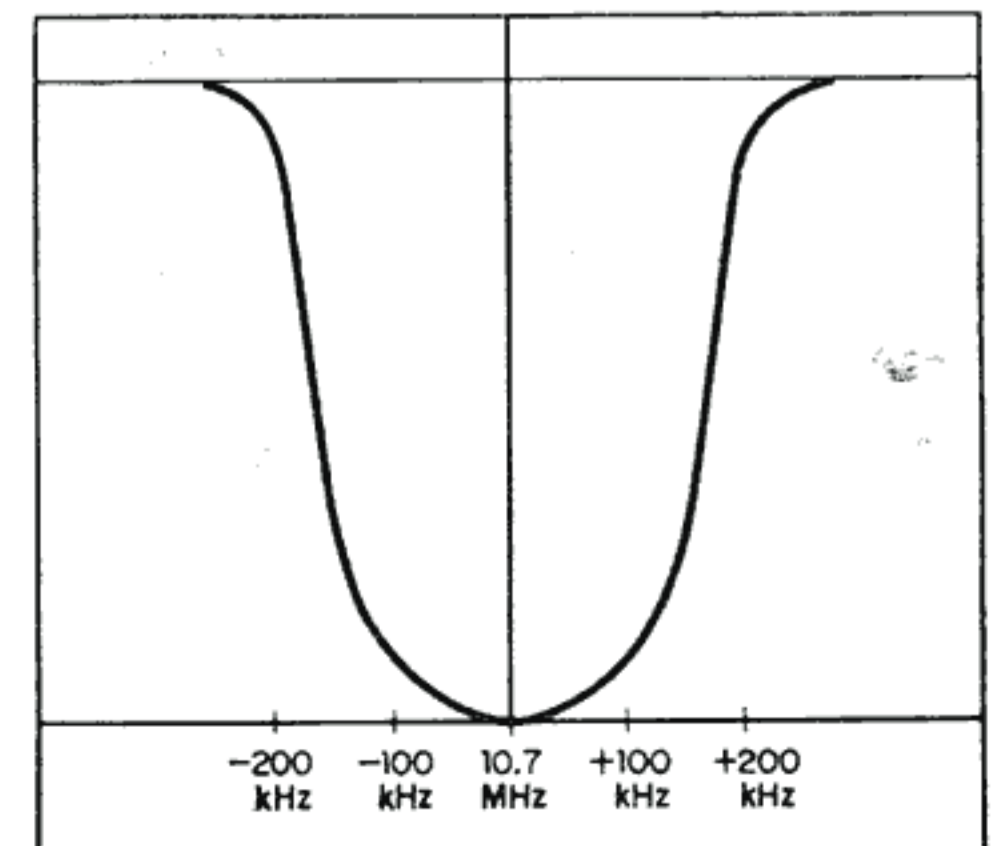

ALIGNMENT

FM MULTIPLEX CIRCUIT

STEP	ALIGN	GENERATOR	FEED SIGNAL	OUTPUT INDICATOR	DIAL SETTING	ADJUST	ADJUST FOR
1.	19 kHz phase	FM signal generator—98MHz Stereo signal generator—composite signal with pilot signal, left chan, 30% modulation.	To antenna terminal	Connect distortion meter to right chan. load terminal	98MHz	L ₄₀₁	Min. distortion in right chan.
2.	Stereo separation	Same as above	Same as above	Connect oscilloscope and valve voltmeter to load terminal	Same as above	VR ₆₀₁	Max. separation

AM TUNER ALIGNMENT PROCEDURE

STEP	ALIGN	GENERATOR	FEED SIGNAL TO	CONNECT	DIAL SETTING	ADJUST	ADJUST FOR
1.	IF	455 kHz ±30 kHz sweep generator	Antenna terminals	Oscilloscope to 3D		T ₃₀₁	Best I.F.T. wave form
2.	O.S.C.	AM signal generator 535 kHz 400 Hz 30% modulation	Antenna terminals	Oscilloscope & V.T.V.M. to output load	535 kHz	O.S.C. coil (T ₃₀₂)	Maximum
3.	O.S.C.	1600 kHz 400 Hz 30% modulation	Antenna terminals	Oscilloscope & V.T.V.M. to output load	1600 kHz	O.S.C. trimmer (TC ₃₀₂)	Maximum
4.	Reiterate 2, 3						
5.	Antenna circuit	600 kHz 400 Hz 30% modulation	Antenna terminals	Oscilloscope & V.T.V.M. to output load	600 kHz	Ferrite antenna coil (T ₃₀₃)	Maximum
6.	Antenna circuit	1400 kHz 400 Hz 30% modulation	Antenna terminals	Oscilloscope & V.T.V.M. to output load	1400 kHz	Trimmer (TC ₃₀₁)	Maximum
7.	Reiterate 5, 6						

AM IF CHARACTERISTIC

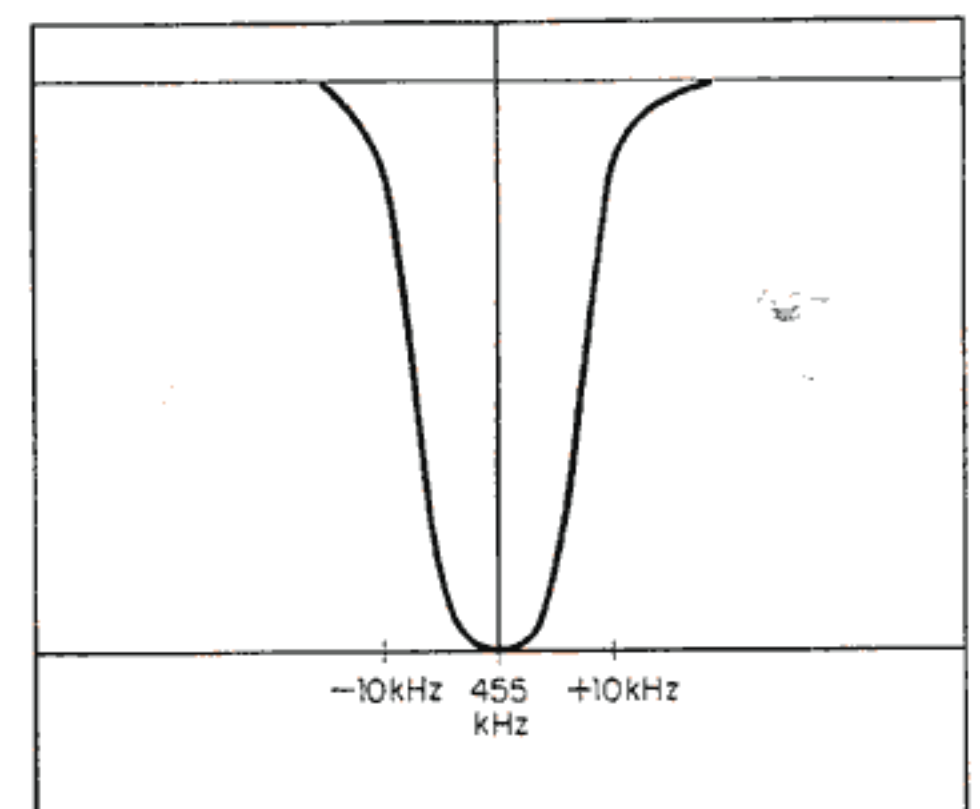

PRINTED CIRCUIT BOARDS AND PARTS LIST

W: Parts No. X: Parts Name Y: Stock No. Z: Position of Parts

AM IF BLOCK <F-1255A>

W	X	Y	Z
R301	2.2kΩ	0101222	2 A
R302	1kΩ	0101102	2 A
R303	10kΩ	0101103	2 A
R304	47kΩ	0101473	2 A
R305	22kΩ	0101223	1 A
R306	3.9kΩ	0101392	1 A
R307	1kΩ	0101102	1 A
R308	10Ω	0101100	1 A
R309	180kΩ	0101184	2 B
R310	2.2kΩ	0101222	2 B
R311	1kΩ	0101102	2 A, B
R312	100Ω	0101101	1 B
R313	1.2kΩ	0101122	1, 2 B
R314	47kΩ	0101473	2 B, C
R315	22kΩ	0101223	1 B
R316	68kΩ	0101683	1 B
R317	1kΩ	0101102	2 B, C
R318	1.8kΩ	0101182	1 B
R319	1kΩ	0101102	1 C
R320	270Ω	0101271	1 C
R321	10kΩ	0101103	2 C
R322	1kΩ	0101102	2 C
R323	56kΩ	0101563	2 C
R324	4.7kΩ	0101472	2 C
R325	270kΩ	0101274	1 C
R326	150Ω	0101151	1 C
R327	1.8kΩ	0101182	1 C
R328	270Ω	0101271	1 B
VR301	47kΩ (B) Meter Adj.	1035170	1 C
C301	0.02μF } +80% -20% 25 V CC.	0659005	2 A
C302	0.04μF } -20%	0659006	1 A
C303	3.3μF	0515339	1 A
C304	0.04μF } +80% -20% 25 V CC.	0659006	2 A
C305	0.01μF ±10% 50 V MC.	0601107	1 A
C306	0.04μF } +80% -20% 25 V CC.	0659006	1 A
C307	0.01μF ±10% 50 V MC.	0601107	1 A
C308	470 pF ±5% 50 V SC.	0621471	1 B
C309	15 pF ±10% 50 V CC.	0660150	1 B
C310	0.04μF } +80% -20% 25 V CC.	0659006	2 B, C
C311	1μF	0515109	2 B
C312	0.04μF } +80% -20% 25 V CC.	0659006	2 B
C313	0.02μF } -20%	0659005	2 B
C314	0.04μF } +80% -20% 25 V CC.	0659006	2 C
C315	0.02μF } +80% -20% 25 V CC.	0659005	2 C
C316	0.0047μF } ±10% 50 V MC.	0601476	2 C
C317	0.0047μF } ±10%	0601476	2 C
C318	0.022μF } ±10% 50 V MC.	0601227	2 C
C319	47μF	0512470	1 B
C320	0.04μF } +80% -20% 25 V CC.	0659006	1 B
C321	100 pF ±5% 50 V SC.	0621101	1, 2 C
C322	0.02μF } +80% -20% 25 V CC.	0659005	1 C
C323	10μF	0511100	1 C
C324	0.04μF } +80% -20% 25 V CC.	0659006	1 B
C325	47μF	0512470	1 B
C326	47μF	0510470	1 C
C327	47 pF ±10% 50 V CC.	0660470	
TR301		0305350, 1	2 A
TR302		0305350, 1	2 B
TR303		0305350, 1	2 B
TR304		0305350, 1	1 A
TR305		0305350, 1	1 C

W	X	Y	Z
D301	IN34A	0310400	1 A
D302		0310400	2 C
D303		0310400	1 C
D304		0310400	1 C
T301	Ceramic Matching Coil	4230390	2 A
T302	OSC Coil	4220200	1 B
CF301	Ceramic Filter	0910090	2 B

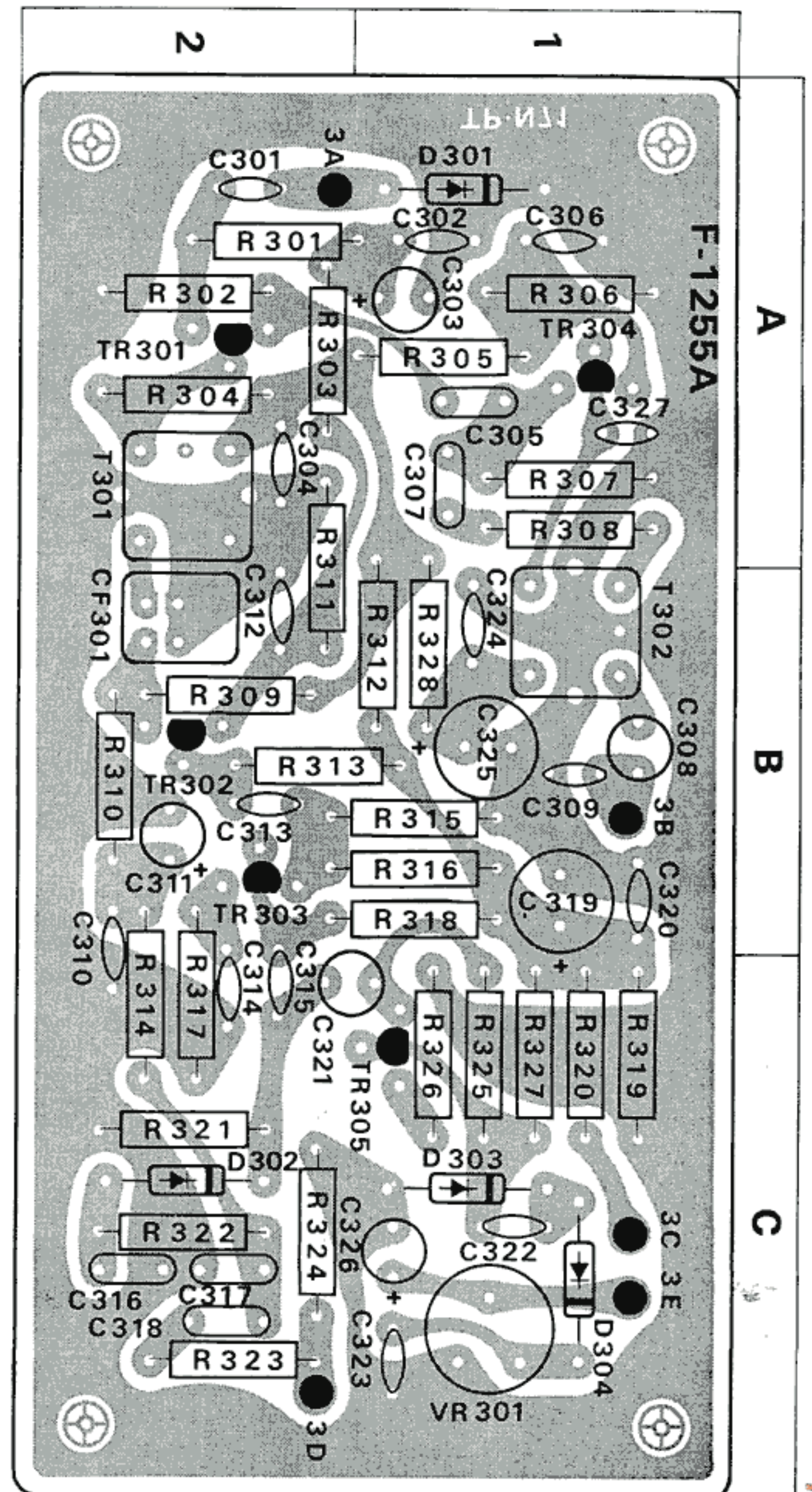

PRINTED CIRCUIT BOARDS AND PARTS LIST

W: Parts No. X: Parts Name Y: Stock No. Z: Position of Parts

FM IF BLOCK <F-1243A>

W	X	Y	Z	W	X	Y	Z	
R201	220Ω	0100221	2 C	C209	0.02μF	0659005	2 B	
R202	15kΩ	0100153	2 C	C210	0.02μF } +80% 25 V CC.	0659005	2 B	
R203	4.7kΩ	0100472	2 C	C211	0.02μF } -20%	0659005	2 B	
R204	1kΩ	0100102	2 C	C212	0.04μF } +80% 25 V CC.	0659006	2 A	
R205	390Ω	0101391	2 C	C213	220 pF } ±10% 50 V CC.	0660221	2 A	
R206	680Ω	0101681	2 C	C214	220 pF }	0660221	2 A	
R207	3.3kΩ	0100332	2 C	C215	10μF	0513100	1 A	
R208	1.5kΩ	0100152	2 C	C216	0.02μF } +80% 25 V CC.	0659005	1 C	
R209	220Ω	0100221	2 C	C217	47 pF } ±10% 50 V CC.	0660470	1 C	
R210	1kΩ	0100102	2 C	C218	0.02μF } +80% 25 V CC.	0659005	1 C	
R211	390Ω	0100391	2 C	C219	47 pF }	0660470	1 C	
R212	680Ω	0101681	2 C	C220	22 pF } ±10% 50 V CC.	0660220	2 C	
R213	3.3kΩ	0100332	2 B	C221	22 pF }	0660220	1 B	
R214	1.5kΩ	0100152	2 B	C222	0.02μF } +80% 25 V CC.	0659005	1 B	
R215	220Ω	0100221	2 B	C223	0.02μF } -20%	0659005	1 B	
R216	1kΩ	0100102	2 B	C224	22 pF } ±10% 50 V CC.	0660220	1 B	
R217	390Ω	0100391	2 B	C225	22 pF }	0660220	1 B	
R218	680Ω	0101681	2 B	C226	0.02μF } +80% 25 V CC.	0659005	1 B	
R219	270Ω	0101271	2 B	C227	3.3μF	0515339	1 B	
R220	56Ω	0100560	2 B	C228	0.02μF } +80% 25 V CC.	0659005	1 A	
R221	390Ω	0101391	2 A	C229	0.02μF } -20%	0659005	1 A	
R222	1kΩ	0101102	2 A	C230	47μF	0512470	1 A	
R223	1kΩ	0101102	2 A	C231	220 pF } ±10% 50 V CC.	0660221	2 A	
R224	10kΩ	0100103	1 C	C232	0.33μF } ±10% 50 V MC.	0651338	2 A	
R225	100Ω	0101101	1, 2 C	C233	10μF	0513100	1 A	
R226	1.5kΩ	0101152	1 C	C234	0.02μF } +80% 25 V CC.	0659005	1 A	
R227	330Ω	0100331	1 C	TR201		0305791	2 C	
R228	10kΩ	0101103	1 C	TR202		0305791	2 C	
R229	1.5kΩ	0100152	1 C	TR203	2SC930D	0305791	2 B	
R230	680Ω	0101681	1, 2 C	TR204		0305791	1 C	
R232	22kΩ	0100223	1 B	TR205		0305791	1 B	
R233	68Ω	0100680	1 B	TR206		0305791	1 B	
R234	2.2kΩ	0100222	1 B	TR207	2SK24 (E, F) FET	0370060, 1	1 A	
R235	1.2kΩ	0100122	1 B	D201		0310331	1 C	
R236	560Ω	0100561	1 B	D202	IN60	0310331	1 C	
R237	100Ω	0101101	1, 2 B	D203		0310331	1 B	
R238	4.7kΩ	0101472	1 B	D204		0310331	1 B	
R239	1kΩ	0101102	1, 2 A	IC201	TA7027M	0360020	2 A, B	
R240	100Ω	0101101	2 A	T201	Discriminating Transformer	4235800	2 A	
R241	1kΩ	0101102	1, 2 A	T202	Meter Coil	4235660	1 B	
R242	1MΩ	0101105	1 A	CF201		0910100	2 C	
R243	1MΩ	0101105	1 A	CF202		or 0910101		
R244	4.7kΩ	0101472	1 A	CF203		0910100	2 C	
R245	15kΩ	0101153	2 A	CF204	Ceramic Filter	or 0910101		
R246	18kΩ	0101183	2 A	CF205		0910100	2 B	
VR201	22kΩ B	1035150	1 A	CF206			or 0910101	
VR202	47kΩ B	1035170	1 A	L201		Micro Inductor	4900010	1 C
C201	0.02μF	0659005	2 C	L202			4900100	2 C
C202	0.02μF	0659005	2 C	L203			4900100	2 C
C203	0.02μF	0659005	1 C					
C204	0.02μF } +80% 25 V CC.	0659005	2 C					
C205	0.02μF } -20%	0659005	2 C					
C206	0.02μF	0659005	2 B					
C207	0.02μF	0659005	2 B					

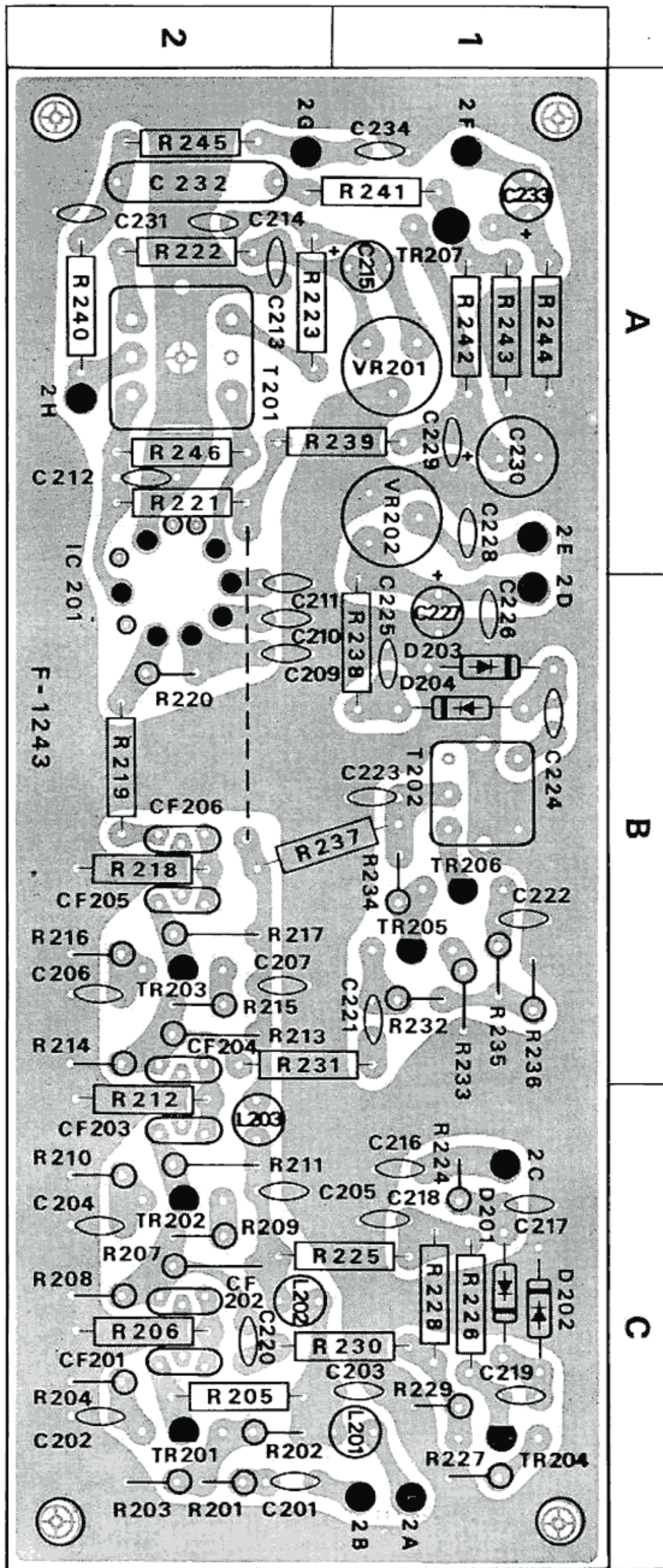

- CR** : Carbon Resistor
- SR** : Solid Resistor
- CeR** : Cement Resistor
- AEC** : Aluminum Solid Electrolytic Capacitor
- MC** : Mylar Capacitor
- EC** : Electrolytic Capacitor
- OC** : Oil Capacitor
- SC** : Styrol Capacitor
- CC** : Ceramic Capacitor

PRINTED CIRCUIT BOARDS AND PARTS LIST

W: Parts No. X: Parts Name Y: Stock No. Z: Position of Parts

MPX BLOCK (F-1283C)

W	X	Y	Z	W	X	Y	Z
R401	1k Ω	0100102	1 C	VR402	220k Ω (B) Stereo Indicator Adj.	1035210	2 A, B
R402	1k Ω	0100102	1 C	C401	100 pF $\pm 10\%$ 50 V CC.	0660101	1 C
R403	100k Ω	0100104	1 C	C402	100 pF } $\pm 5\%$ 50 V SC.	0620101	1 C
R404	22k Ω	0100223	1 C	C403	4700 pF }	0620472	2 C
R405	100k Ω	0101104	1, 2 C	C404	10 μ F 10 V EC.	0511100	1 C
R406	68k Ω	0100683	1 C	C405	6800 pF $\pm 5\%$ 50 V SC.	0629001	1 C
R407	6.8k Ω	0100682	1 C	C406	0.022 μ F $\pm 10\%$ 50 V MC.	0601227	2 C
R408	22k Ω	0100223	2 C	C407	3.3 μ F 50 V EC.	0515339	1, 2 B
R409	100k Ω	0100104	2 B	C408	10 μ F 25 V EC.	0513100	1 B
R410	100k Ω	0100104	2 B	C409	10 μ F 10 V EC.	0511100	1 B
R411	220 Ω	0100221	2 B	C410	0.1 μ F $\pm 10\%$ 50 V MC.	0601108	1 A
R412	1.8k Ω	0100182	2 B	C411	820 pF $\pm 5\%$ 50 V SC.	0620821	1 A
R413	22k Ω	0100223	2 B	C412	0.1 μ F $\pm 10\%$ 50 V MC.	0601108	1 A
R414	220k Ω	0100224	1 A	C413	820 μ F } $\pm 5\%$ 50 V SC.	0620821	1, 2 A
R415	4.7k Ω	0100472	1 A	C414	3300 pF }	0620332	1 A
R416	4.7k Ω	0100472	1 A	C415	3300 pF }	0620332	1, 2 A
R417	220k Ω	0100224	1 A	C416	0.02 μ F $\begin{matrix} +80\% \\ -20\% \end{matrix}$ 25 V CC.	0659005	2 C
R418	220k Ω	0100224	1 A	C417	0.68 μ F 25 V AEC.	0563688	2 C
R419	4.7k Ω	0100472	1 A	C418	0.02 μ F $\begin{matrix} +80\% \\ -20\% \end{matrix}$ 25 V CC.	0659005	2 B
R420	4.7k Ω	0100472	1 A	C419	1 μ F 50 V EC.	0515109	2 B
R421	220k Ω	0100224	1 A	C420	0.02 μ F $\begin{matrix} +80\% \\ -20\% \end{matrix}$ 25 V CC.	0659005	2 B
R422	56k Ω	0100563	1 A	C421	0.0033 μ F $\pm 10\%$ 50 V MC.	0601336	2 C
R423	56k Ω	0100563	1 A	C422	100 μ F 25 V EC.	0513101	2 B, C
R424	56k Ω	0100563	1 A	C423	100 μ F 10 V EC.	0511101	2 A
R425	56k Ω	0100563	1 A	C424	0.68 μ F 25 V AEC.	0563688	2 A
R426	1M Ω	0100105	2 C	TR401	2SC871F	0305472	1 C
R427	3.3k Ω	0100332	2 C	TR402	2SA562 (O, Y)	0300220, 1	2 B
R428	56 Ω	0100560	2 C	TR404	} 2SC711 (E, F)	0305731, 2	2 C
R429	3.3k Ω	0100332	2 C	TR405		0305731, 2	2 B
R430	220k Ω	0100334	2 B	TR406		0305731, 2	2 C
R431	100k Ω	0100104	2 B	TR407		0305731, 2	2 C
R432	1.2k Ω	0100122	1 C	TR408	} 2SC733 (O, Y)	0305370, 1	2 B
R433	47k Ω	0100473	2 B	TR409		0305370, 1	2 B
R434	47k Ω	0100473	2 B	TR410		0305370, 2	2 B
R435	47k Ω	0100473	2 B	TR411	} 2SC711 (E, F)	0305370, 2	2 A
R436	22k Ω	0100223	2 A	TR412		0305731, 2	2 A
R437	22k Ω	0100223	2 A	TR413		0305731, 2	2 A
R438	22k Ω	0100223	2 A	TR414		0305731, 2	2 A
R439	100 Ω	0100101	2 A	TR415	} 2SC733 (O, Y)	0305370, 1	1 A
R440	22k Ω	0100223	2 B	TR416		0305370, 1	1 A
R441	47k Ω	0100473	2 B	D401	} IN34A	0310400	2 C
R442	100k Ω	0100104	2 C	D402		0310400	2 C
R443	56k Ω	0100563	2 C	D403		0310401	1 A
R444	100 Ω	0101101	2 C	D404	} IN34AY	0310401	1 A
R445	22k Ω	0100223	2 C	D405		0310401	1 A
R446	1.2k Ω	0111122	2 C	D406		0310401	1 A
R447	100k Ω	0100104	2 A	D407	} IN34A	0310400	2 C
R449	47k Ω	0100473	2 A	D408		0310400	2 A
R450	47k Ω	0100473	2 A	D409		0310340	2 A
R451	22k Ω	0100223	2 A	L401	MPX Cil	4240510	1 C
R452	22k Ω	0100223	2 A	L402	} Micro Inductor	4900100	1, 2 C
R453	22k Ω	0100223	2 A	L403		4900120	2 C
R454	22k Ω	0100223	2 A	LC401	} MPX Coil	4240490	1 B, C
R455	47k Ω	0100473	2 A	LC402		4240500	1 B, C
R456	100 Ω	0100101	2 A	Cd401	MCL1014	0920021	2 C
R457	10k Ω	0100103	2 A				
R458	22k Ω	0100223	2 A				
R459	47 Ω	0100470	2 A				
R460	820 Ω	0100821	2 B				

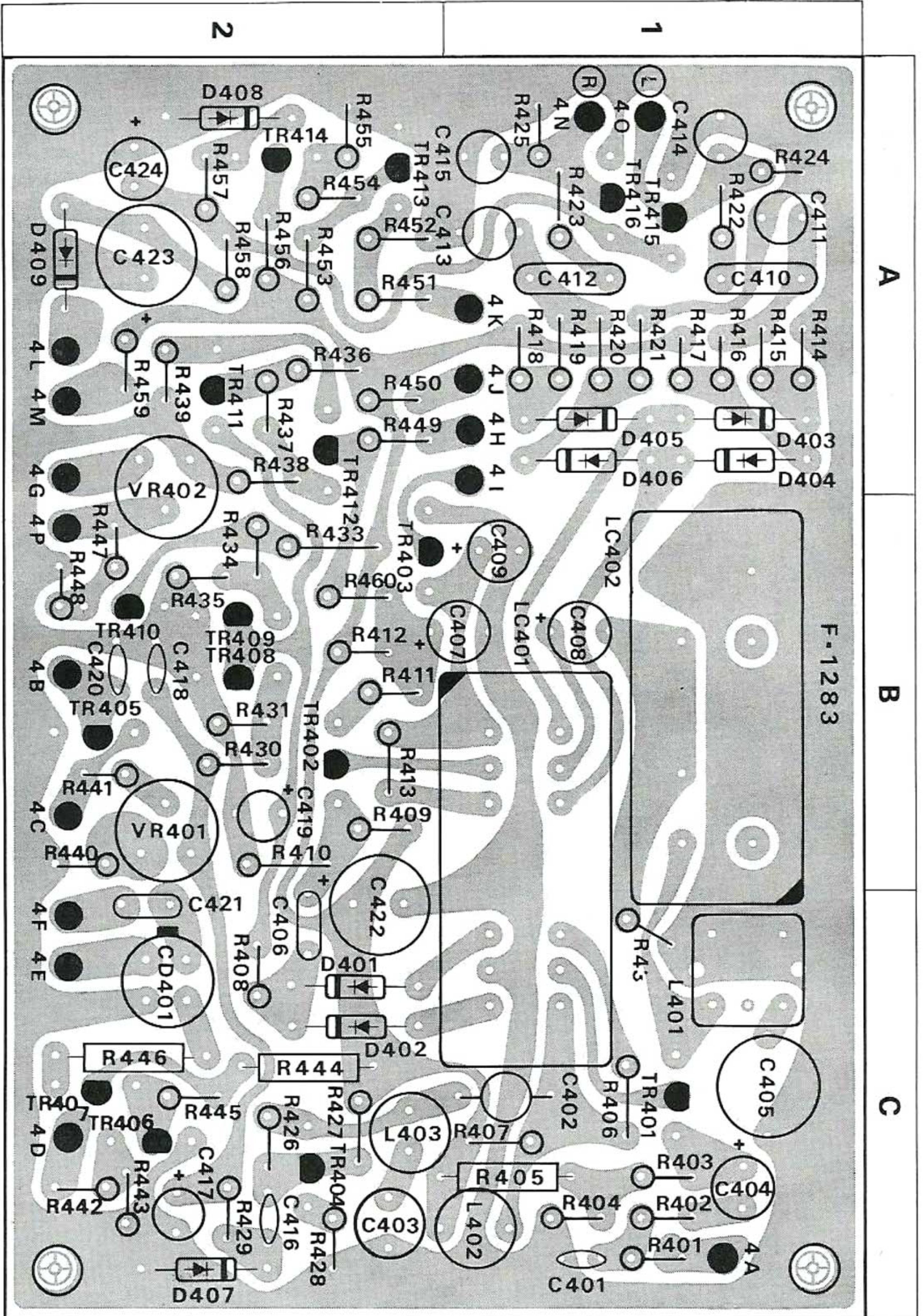

PRINTED CIRCUIT BOARDS AND PARTS LIST

W: Parts No. X: Parts Name Y: Stock No. Z: Position of Parts

AUDIO AMP BLOCK <F-1306>

W	X	Y	Z
R601	2.2kΩ	0101222	2 A
R602	2.2kΩ	0101222	1 A
R603	470kΩ	0101474	2 A
R604	470kΩ	0101474	1 A
R605	100kΩ	0101104	2 A
R606	100kΩ	0101104	1 A
R607	39kΩ	0101393	2 A
R608	39kΩ	0101393	1 A
R609	47kΩ	0101473	2 A
R610	47kΩ	0101473	1 A
R611	4.7kΩ	0101472	2 A
R612	4.7kΩ	0101472	1 A
R613	100kΩ	0101104	2 A
R614	100kΩ	0101104	1 A
R615	2.7kΩ	0101272	2 A
R616	2.7kΩ	0101272	1 A
R617	820Ω	0101821	2 B
R618	820Ω	0101821	1 B
R619	18kΩ	0101183	2 C
R620	18kΩ	0101183	1 C
R621	150kΩ	0101154	2 C
R622	150kΩ	0101154	1 C
R623	82kΩ	0101823	2 C
R624	82kΩ	0101823	1 C
R625	12kΩ	0101123	2 C
R626	12kΩ	0101123	1 C
R627	2.7kΩ	0101272	2 C
R628	2.7kΩ	0101272	1 C
R629	82kΩ	0101823	2 C
R630	82kΩ	0101823	1 C
R631	2.2kΩ	0101222	2 C
R632	2.2kΩ	0101222	1 C
R633	68kΩ	0101683	2 C
R634	68kΩ	0101683	1 C
R635	15kΩ	0101153	2 C
R636	15kΩ	0101153	1 C
R637	47Ω	0101470	2 C
R638	2.7kΩ	0101272	2 A
VR601	47kΩ (B) Separation Adj.	1035170	1, 2 A
C601	0.47 μF	0563478	2 A
C602	0.47 μF	0563478	1 A
C603	3.3 μF	0515339	2 A
C604	3.3 μF	0515339	1 A
C605	10 μF	0513100	2 A
C606	10 μF	0513100	1 A
C621	0.47 μF	0563478	2 C
C622	0.47 μF	0563478	1 C
C623	10 μF	0513100	2 C
C624	10 μF	0513100	1 C
C625	33 μF	0515330	1, 2 A
C626	0.001 μF	0601106	1, 2 A
TR601	2SC871R (E.F.G)	0305474, 5, 6	2 A
TR602		0305474, 5, 6	1 A
TR603		0305474, 5, 6	2 A
TR604		0305474, 5, 6	1 A

W	X	Y	Z
TR605	2SC871	0305471, 2	2 C
TR606		0305471, 2	1 C
TR607		0305471, 2	2 C
TR608		0305471, 2	1 C
LPF601	Low Pass Filter	0910110	1, 2 B

POWER BLOCK <F-1294>

W	X	Y	Z		
R001	1.2k Ω	±10% ¼W CR.	0101122	1 A	
R002	22 Ω		0101220	1 B	
R003	470 Ω		±10% 2 W CeR.	0152471	1 B
R004	330 Ω			0152331	2 B
R005	470 Ω		±10% ¼W CR.	0101471	1 B
C001	1000 μ F	50 V EC.	0549103	2 A	
C002	1000 μ F	25 V EC.	0513102	1, 2 A	
C003	100 μ F		0513101	2 A	
C004	0.02 μ F	+80% -20%	25 V CC.	0659005	1 B
C005	220 μ F	25 V EC.	0103221	1, 2 B	
C006	100 μ F	16 V EC.	0102101	1, 2 B	
C007	220 μ F		0102221	2 B	
C008	470 μ F	6.3 V EC.	0100471	2 B	
C009	0.02 μ F	+80% -20%	500V CC.	0659009	1 A
C010	0.02 μ F		0659009	1 A	
TR001	2SD223 (Y, G)		3808231, 2	1 A	
D001	10DC (N)		0310800	1 A	
ZD001	ZBI-25 Zener Diode		0310710	2 A	
ZD002	ZBI-12 Zener Diode		0310641	1 B	
SCR001	IRC-5 SCR		0350050	1 A	

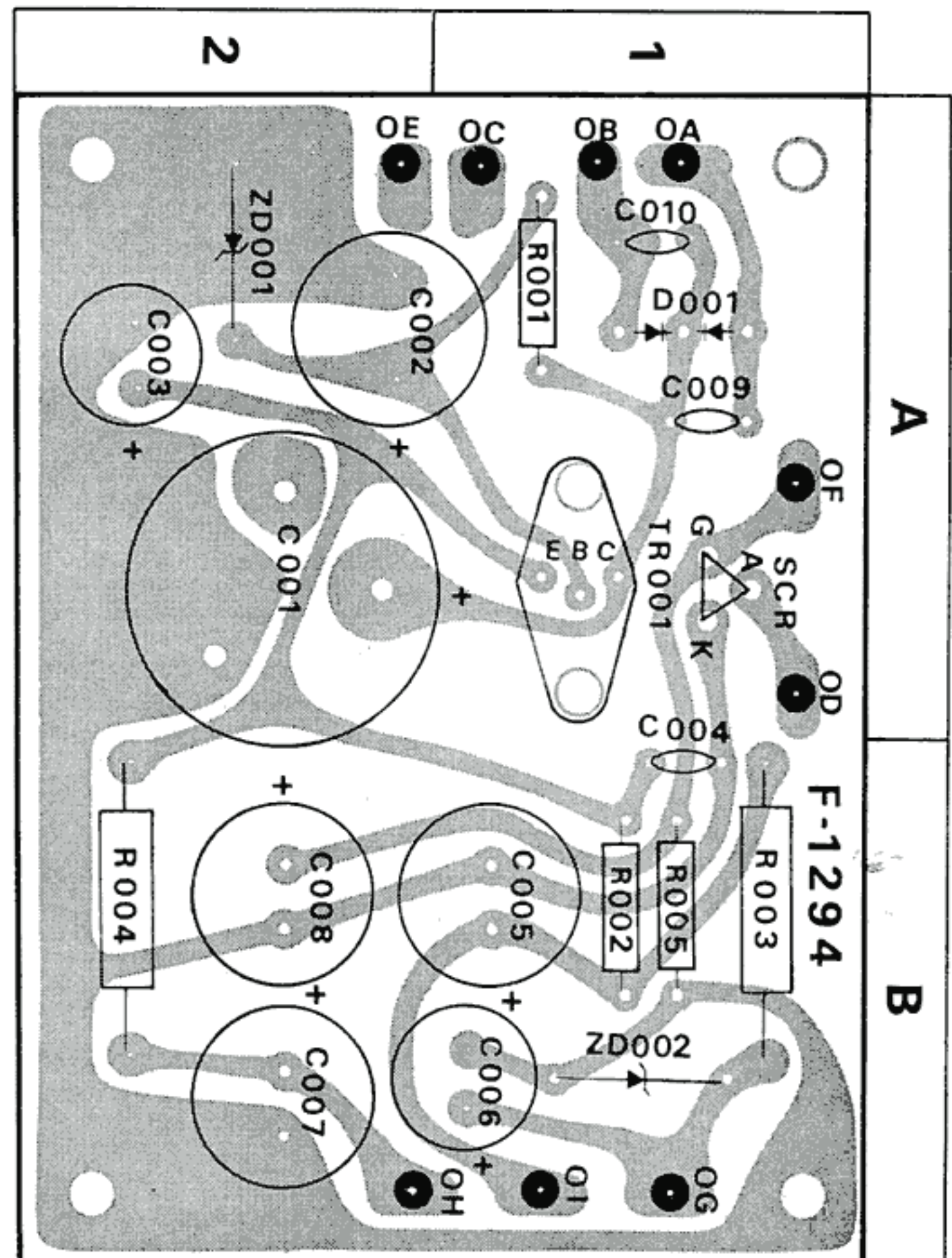
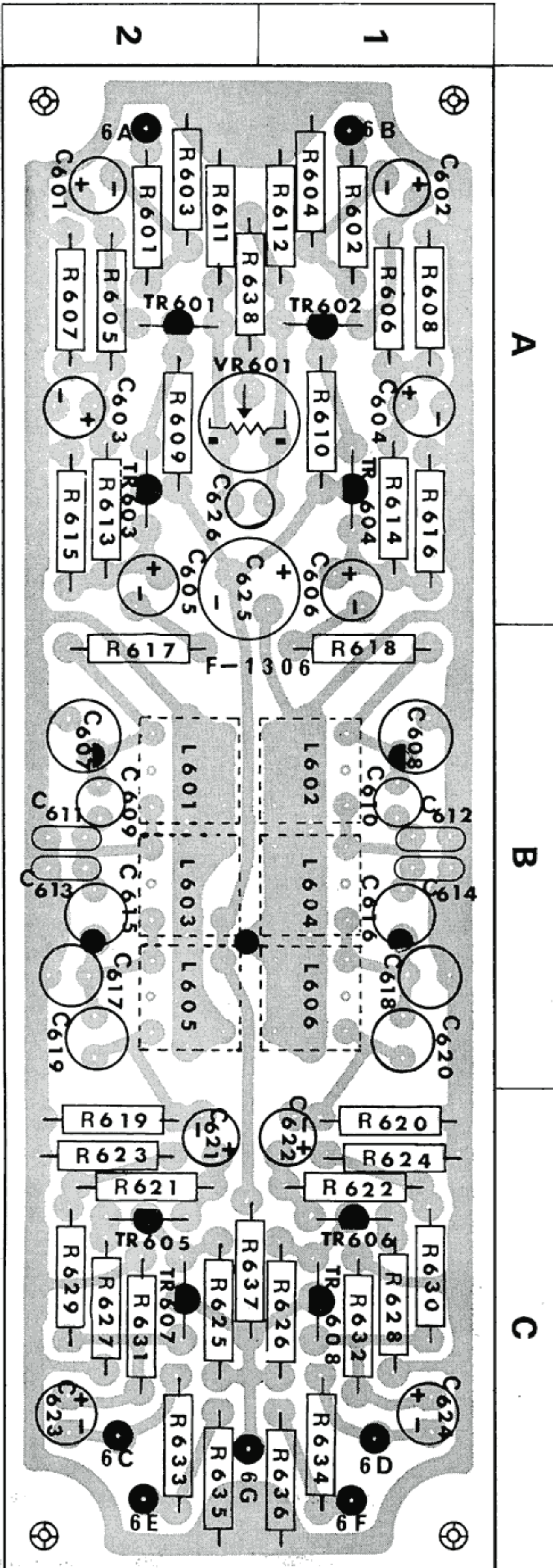

ACCESSORIES

W: Parts No. X: Parts Name Y: Stock No.

Accessories List

1. FM ANTENNA	1
2. AM ANTENNA	1
3. OPERATING SHEET	1
4. OPERATING INSTRUCTIONS AND SERVICE MANUAL	1
5. CONNECTION CORDS WITH PIN-PLUGS...	2
6. BUTTERFLY BOLTS	2
7. WASHERS.....	2
8. POLISHING CLOTH.....	1

OTHER PARTS

W	X	Y
R015	18Ω	0101180
R016	68Ω	0101680
R017	680Ω	0101681
R018	100Ω	0101101
R019	47Ω	0101470
R020	330Ω	0101331
R021	56kΩ	0101563
R256	8.2kΩ	0101822
VR001	10kΩ(B) × 2	1010560
VR002	100kΩ(B)	1005041
C020	0.033μF	0591337
C021	0.0047μF	0591476
C022	0.02μF	0659005
C023	0.02μF	0659005
T001	400-5399 Power Transformer	4000770
T002	High Frequency Transformer	4290021
T303	AM Bar Antenna	4200380
L002	Micro Inductor	4900110
S1	Selector	1102200
S2	Power SW.	1170200
S3	FM Muting	1170120
S4	MPX Noise Canceler	1170120
S5	Antenna Dist.—Loc Selector	1110040
PL001	Pilot Lamp	0420020
PL002		0420020
PL003		0420020
PL004		0420020
PL005		0420020
PL006		0420020
PL007		0420020
PL008		0400110
PL009		0400110
PL010		0400100
PL011		0400110
F001	1A Fuse (100~117V)	0430022
	0.5A Fuse (220~240V)	0430012
M001	Tuning Meter	0900310
M002	Center Meter	0900320
PU001	Voltage Selector Socket	2410080
	Voltage Selector Plug	2410090

* Manufacturer reserves right to change design and/or specifications without notice for purpose of improvement.

OTHER PARTS AND THEIR POSITION ON CHASSIS

